

Rastko Mladenović

Research Assistant
Institute of Nuclear Sciences "Vinča"

Milijana Paprika

Research Assistant
Rafako Engineering Solutions, Belgrade

Mirko Komatina

Full Professor
University of Belgrade
Faculty of Mechanical Engineering

Aleksandar Erić

Research Assistant
Institute of Nuclear Sciences "Vinča"

Milica Mladenović

Research Assistant
Institute of Nuclear Sciences "Vinča"

Dragoljub Dakić

Senior Researcher
Institute of Nuclear Sciences "Vinča"

Boiler Combusting Large Soya Straw Bales for Heating the Greenhouses Complex

In one of the largest agricultural companies in Serbia with over 2000 ha of soya plantations there is 4000 t/year of baled soya straw production. Soya straw biomass is planned to be used as renewable energy source for heating the greenhouses, with 5 ha in area. Therefore, efforts have been made to develop a technology for utilizing large bales of soya straw for energy production. In the first phase, a demo energy production facility – furnace was developed and built. The facility was tested in order to examine the quality of combustion of large soya straw bales. Since the experimental results obtained by testing of this facility proved to be very satisfactory, in the second phase of development, the hot water boiler of similar characteristics (burning soya straw bales, with dimensions 0.7 x 1.2 x 2.7 m) was designed.

Keywords: soya straw, bales, combustion, boiler, agricultural biomass, greenhouse heating.

1. INTRODUCTION

The reserves of waste biomass from agricultural production in Serbia are very abundant. It is estimated that some 7000000 tons of this biomass is collected each year, with only a small portion of it being actually used for energy purposes. The total available energy potential of different types of waste biomass in Serbia is 135600 TJ/year, with straw and corn stems comprising a significant part – approximately 35500 TJ/year [1]. This biomass is a cheap and available fuel, but its utilization is linked to the problems of its collection, preparations for its transportation (cutting, tying into haystacks, baling), transportation and storage [2]. These problems are less significant and easier to handle if the biomass is used for energy purposes near places of its collection, in enterprises dealing with agricultural production, where the obtained energy – heat – could be used for heating of greenhouses, stables, poultry raising farms, offices, etc.

In the Agricultural Corporation PKB – Belgrade, one of the largest agricultural companies in Serbia, there are over 2000 ha of soya plantations. Each year after the harvest over 4000 tons of soya straw remains. Straw in general is a fuel of low calorific value [3]. This straw is baled, and is not used for energy purposes further on. At the same time, there is a need for heating of greenhouses inside the company, with the total greenhouse area to be heated equal to 5 ha. Until now, a technology for efficient combustion of baled material of this size has not been developed in Serbia. In the European Union, some technical solutions for solving these problems have been reported [4-6].

In the Laboratory for Thermal Engineering and Energy of the "Vinča" Institute in Belgrade, efforts have been made to develop a clean technology for utilizing baled biomass for energy production. As a result, an energy production facility – boiler (with thermal power of 1.5 MW) has been developed, for combustion of large soya straw bales. The first phase of the development was the building-up and testing of a real-scale demo energy production facility – furnace – with combustion of large rolled soya straw bales and with thermal power of 1 MW. The furnace was tested in order to examine the quality of combustion and to assess the possibilities for designing a soya straw-fired hot water boiler of similar characteristics. Since the results of these tests have proved to be very satisfactory, the energy facility has been designed and is being built at the moment. The results of the development and basic elements of the boiler design are presented here.

2. CONCEPT OF THE ENERGY FACILITY BURNING LARGE SOYA STRAW BALES

Soya straw bales, formed on the fields of PKB Corporation are square, with dimensions 0.7 x 1.2 x 2.7 m. Average low heating value is 13686 kJ/kg, and the density is 132.27 kg/m³. A scheme of the energy production facility burning the bales is given in Figure 1.

The fuel is fed to the furnace by the bale transporter (position 1 in Fig. 1). The combustion occurs in the furnace (pos. 2), made of refractory material – chamotte. Leaving the furnace chamber, the flue gases pass on to the gas-to-water heat exchanger (pos. 3), and then to the cyclone (pos. 4). The flue gases are run by the fan (pos. 5) and the smokestack (pos. 6). The boiler is equipped with a flue gas-water exchanger (pos. 3) placed downstream of the chamotte-lined furnace, and with screen barriers, multi-stage cyclones and scrubbers for the removal of particles from the flue gases. The boiler will be supplied with a system for automatic excess air control and with safety systems.

Received: March 2008, Accepted: April 2008

Correspondence to: Rastko Mladenović, M.Sc.
Institute of Nuclear Sciences "Vinča",
Laboratory for Thermal Engineering and Energy,
P.O. Box 522, 11001 Belgrade, Serbia
E-mail: rastkom@vin.bg.ac.yu

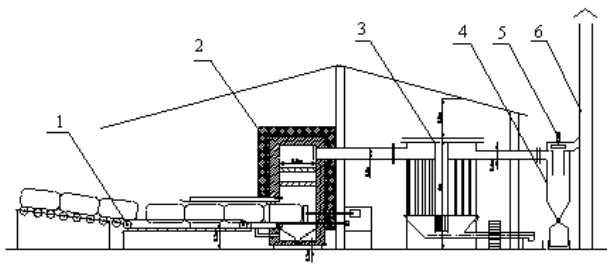

1 – Bale transporter; 2 – Furnace; 3 – Heat exchanger;
4 – Cyclone; 5 – Flue gases fan; 6 – Smokestack

Figure 1. Energy production facility with combustion of large soya straw bales – scheme

The boiler is equipped with a 100 m³ heat storage tank, which allows the whole facility to respond adequately and smoothly to the heating needs of the greenhouse, i.e. to weather changes.

A detailed scheme of the boiler combustion chamber is presented in Figure 2.

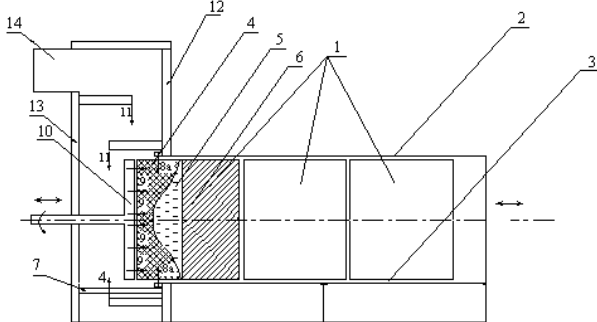

1 – Bales of soya straw; 2 – Fuel feeding channel; 3 – Bale transporter; 4 – Combustion zone; 5 – Devolatilization zone; 6 – Drying zone; 7 – Grate; 8 – Primary air (8a – perimeter nozzles, 8b – nozzles under the grate); 9 – Secondary air; 10 – Bale holder, also used for shaking-off of ash and secondary air supply; 11 – Tertiary air; 12 – Front wall; 13 – Rear wall; 14 – Flue gas exit

Figure 2. The combustion chamber of the boiler burning large bales of soya straw – scheme

Bales of soya straw (position 1 in Fig. 2) are placed into the square cross section-shaped fuel feeding channel (pos. 2). The feeding of the bales is carried out continuously, using the bale transporter (pos. 2) by which the bales are slowly pushed towards the inside of the furnace. The feeding is adjusted according to the thermal power to be achieved, and therefore produced thermal power output of the facility should be stable.

The combustion of the bales is based on the principles of combustion of a cigarette – only the portion of the bale, placed in the furnace itself (the bale forehead), combusts at a time. As the bale forehead is burnt out, the following portion of the bale enters the combustion zone (4) inside the furnace, by means of fuel feeding. This portion had been exposed to devolatilization (5) prior to entering the furnace, due to the heat absorbed from the combustion zone. The portion of the bale placed inside the feeding tube, near the entry point of the feeding tube into the furnace, is exposed to drying (6).

The bale forehead is supported from the bottom by the water cooled grate (7). The combustion air is

supplied in three stages. The primary air (8) is supplied through:

- Eight nozzles placed around the bale, on its perimeter, at the feeding channel entry point into the furnace (8a);
- Two nozzles placed under the grate (8b).

The nozzles have been dimensioned in such a way that primary air supply on the bale perimeter is practically uniform.

The secondary air (9) is supplied through nozzles placed in a movable (both along the bale axis and rotating around the axis) secondary air supplier (10), which is also used for shaking off of the burnt out ash from the bale forehead, and for exact positioning of the bale inside the furnace according to thermal power requirements. This element is water cooled, and run by an engine. The tertiary air (11) is supplied through nozzles placed in the flow barriers in the convection section, just above the furnace. The flow barriers have been designed in order to cool the flue gases and to complete the combustion process as much as possible before the furnace exit.

The air is supplied with two fans, one for primary air supply, and the other, a smaller one, for secondary and tertiary air. The flue gases exit the facility through the opening (14).

3. THE DEMO FURNACE BURNING SOYA STRAW BALES

Before the actual boiler has been built, in order to assess the combustion quality and to obtain data for the design of the soya straw-fired hot water boiler, a demo furnace had been designed and built. The appearance of the furnace is shown in Figure 3. This furnace was adopted for cylindrical bales, with 1.2 m in diameter.



Figure 3. The appearance of the demo facility, with the thermocouple probes, the primary air fan and channel, and the fuel feeding tube

The proximate analysis of soya straw used in tests is given in Table 1.

Table 1. The proximate analysis of soya straw used in the tests

Moisture [%]	Ash [%]	Char [%]	Fixed carbon [%]	Volatile matter [%]	Combustible matter [%]	Net calorific value [kJ/kg]
18.80	5.66	22.12	16.46	59.08	75.54	13686

The inside of the furnace, with the installed thermocouple probe, the movable cross and the grate is shown in Figure 4.

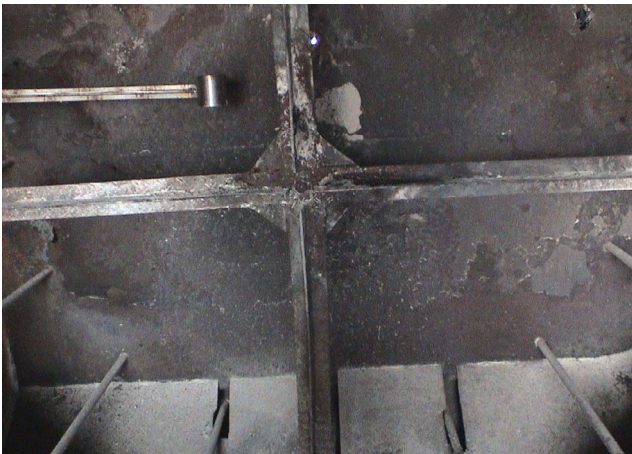

Figure 4. Inside the furnace – the thermocouple probe, the movable secondary air supplier used for secondary air supply and shaking-off of the ash, and the grate

The sum of five tests was done. A summary of main test parameters is given in Table 2.

Table 2. Test parameters

Test	1	2	3	4	5
Number of bales in the feeding tube	1	2	2	3	3
Amount of straw [kg]	134.6	280	327.97	458.3	554.9
Primary air [m ³ /h]	1548	1548	1548	1350	1404**
Secondary air [m ³ /h]	-	-	234	418.25	228.14**
Tertiary air [m ³ /h]	504	252	108	259.2	259.2**
Calculated thermal power [kW] ⁺	485.2	529.3	556.5	551.7	455.7
Average air excess coefficient, λ	not measured	4.71	2.61	4.12*	2.92**
Test duration [min]	47	89	99	140	205

Conditions: ⁺ – The thermal power was calculated over the entire test period; * – The air excess coefficient in Test 4 was calculated for the period shown in the diagrams (Figs. 8 and 9); ** – The air flow rates refer only to the period shown in the diagrams (Figs. 10 and 11), since in Test 5 variable speed drives were used for changing the speed of the fans. The air excess coefficient λ was calculated for the same period.

During all tests, three temperatures were measured, with shielded type K thermocouple probes. Thermocouple probe locations, as well as the location of the gas sampling probe, are shown in Figure 5. Gas sampling was done with a probe placed near the furnace exit (Fig. 5). Gas samples were continuously analyzed with two analyzers, collected every 5 seconds and stored on-line.

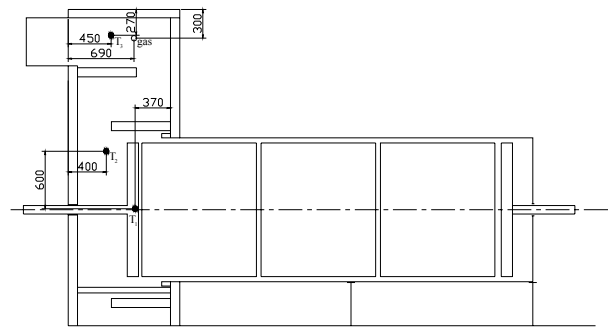

Figure 5. Thermocouple probes and gas sampling locations

It should be noted that secondary air supply through the movable cross was not present in the first version of the furnace, which was examined in Tests 1 and 2. The results from these tests stressed the need to introduce secondary air in the combustion zone, at the bale forehead, and the furnace with secondary air supply was examined in Tests 3, 4 and 5.

Test 1 was conducted with one bale of straw placed in the feeding tube. Only temperature measurements were done, and the results showed that the temperature in the combustion zone, in steady conditions, was quite stable (730 – 830 °C, Fig. 6) for a reasonable period of time (40 minutes). It was noted that the amount of tertiary air did not contribute much to overall combustion conditions, and that in fact this air over-cooled the flue gases in the combustion zone.

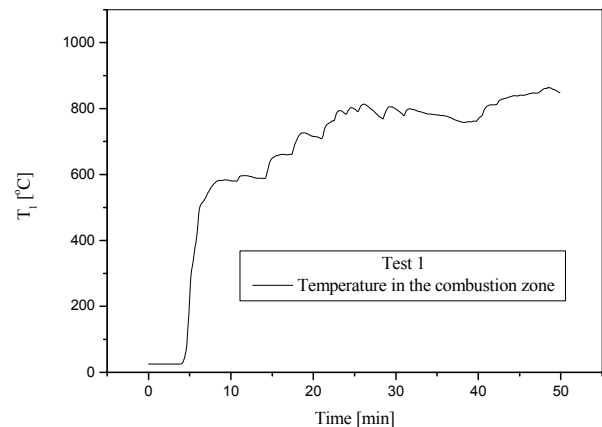

Figure 6. Test 1 – Temperature in the combustion zone

In Test 2, along with temperatures, gas composition was continuously measured. Less air was supplied as tertiary than in Test 1. In the initial, start-up period (Fig. 7), gas samples were taken directly from the combustion zone, and very high levels of CO in the flue gases were noted. After the choking of the gas sampling probe and its cleaning, and also in all following tests, gas samples were taken only from the top of the furnace, as it was shown in Figure 5. As the temperature in this period increased to approximately 1000 °C, bale feeding was slowed down, which corresponds to the temperature downfall (minutes 50 – 75). Soon after that, stable conditions were obtained (Figs. 7 and 8), primarily by adjusting bale feeding.

High level of CO concentration at the furnace top in Test 2 urged the introduction of a small amount (approximately 10 % of total air) of secondary air in the

combustion zone, which would cool down the movable cross at the same time. It was also noted that tertiary air flow rate should be decreased, and therefore secondary air was introduced to the detriment of tertiary air. This change in design was examined in Test 3, with two bales placed in the feeding tube.

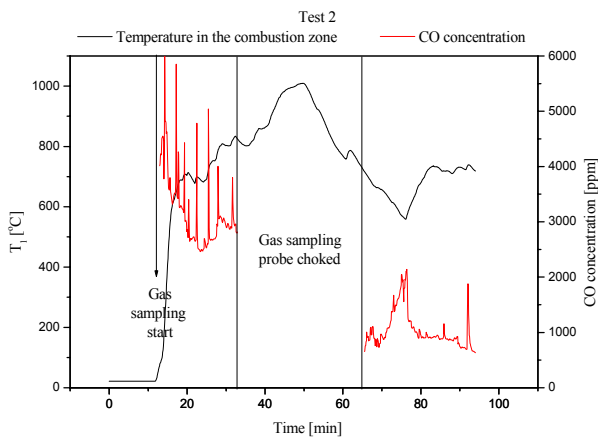

Figure 7. Test 2 – Temperature in the combustion zone vs. CO concentration

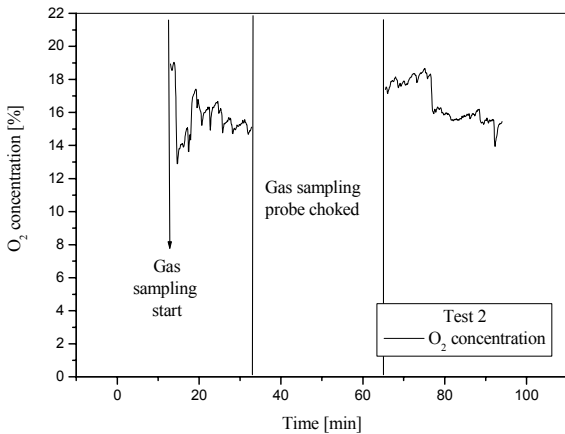

Figure 8. Test 2 – O₂ concentration

The principal aim of Test 4 was to assess the possibility of longer furnace operation, with three bales placed inside the feeding tube. The bales prepared for this test were approximately 1.2 m in diameter, and in order to secure stable manual feeding, the gaps between the tube wall and the bales were manually filled with more straw. Problems with feeding undersized bales caused instabilities in the first hour of the test. In the period shown in Figures 11 and 12, the temperature was in the desired range, and CO concentration was acceptable for most of the period (up to 350 ppm), the only rise in CO occurring at the time of the temperature downfall (minutes 100 – 110). It was spotted by visual inspection, through the inspection openings, that the bale was not inside the furnace at the time of the downfall, due to the problems with manual bale feeding and cross positioning – the bale forehead remained inside the tube. This caused the flame to enter the tube at the time, which also occurred during Test 5.

The supply of the secondary air through the cross provided excellent conditions for combustion completion (Fig. 9) – the concentration of CO was equal to zero for most of the time during the test. The air

distribution (82 % primary air, 12 % secondary, 6 % tertiary) was found to be well suited for maintaining steady conditions inside the furnace. On the other hand, the stability of the thermal output was found to depend largely on the active length of the bale immersed into the furnace. Therefore, it is of great importance to feed the bale uniformly in accordance with the combustion process, and to maintain this length as stable as possible, by moving the bale holder, used also for secondary air supply, accordingly. The temperature instabilities (from the minute 45 further on, Fig. 9) during this test are a consequence of changes of this length. The only peak in CO concentration coincided expectedly with low temperatures during this period. Nevertheless, this test proved that the adopted concept of the furnace provided good conditions for efficient combustion of soya straw bales, with O₂ concentration ranging from 10 – 14 % (Fig. 10), and an optimal average value of λ .

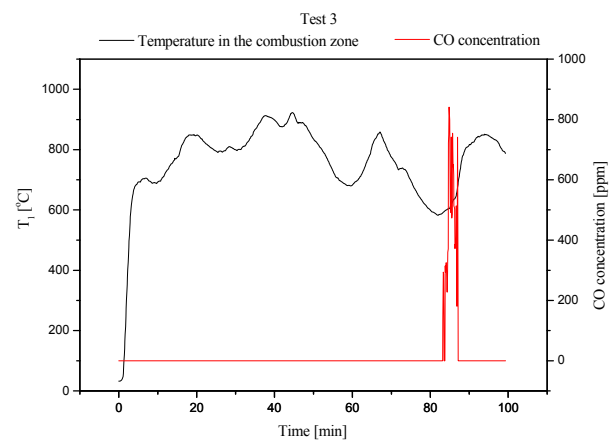

Figure 9. Test 3 – Temperature in the combustion zone vs. CO concentration

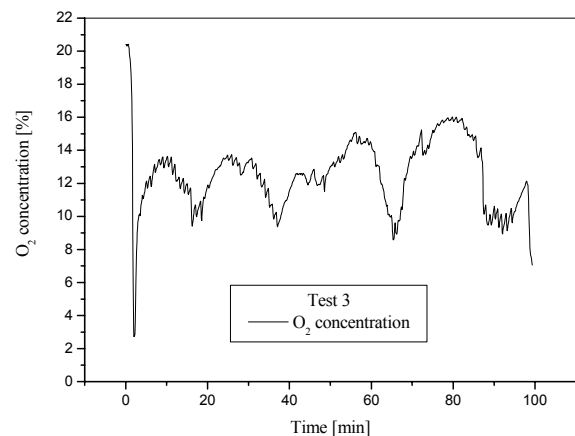

Figure 10. Test 3 – O₂ concentration

The aim of Test 5 was to assess the influence of air flow rate control, with variable speed drives, on furnace performance. During a chosen period of 40 minutes (Figs. 13 and 14), optimal air flow rates were obtained and bale feeding was kept stable. The concentration of CO was very low, with O₂ concentration varying in the range of 10 – 15 %. The temperature during this period was higher than the desired 850 °C (which should not be exceeded in order to avoid ash melting), which will be taken into consideration in some of the conclusions.

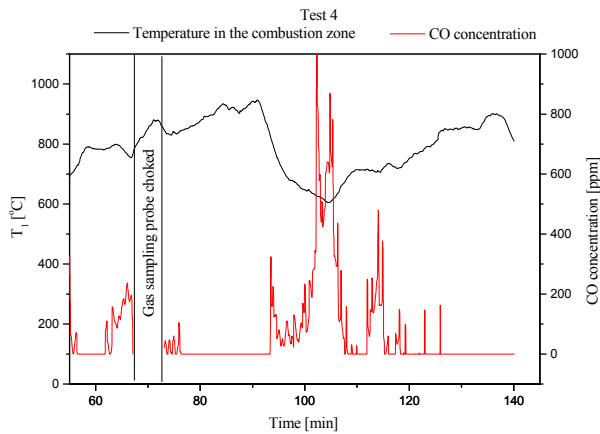

Figure 11. Test 4 – Temperature in the combustion zone vs. CO concentration

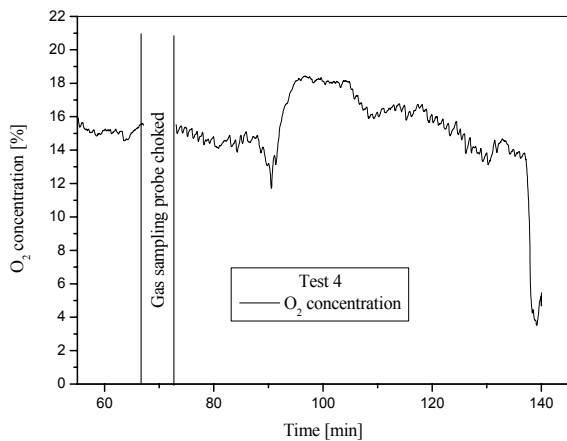

Figure 12. Test 4 – O₂ concentration

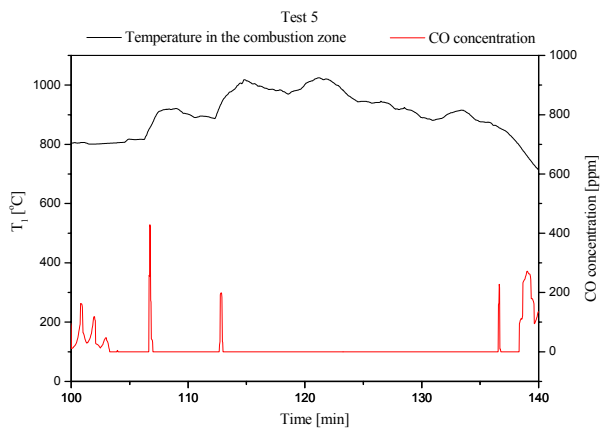

Figure 13. Test 5 – Temperature in the combustion zone vs. CO concentration

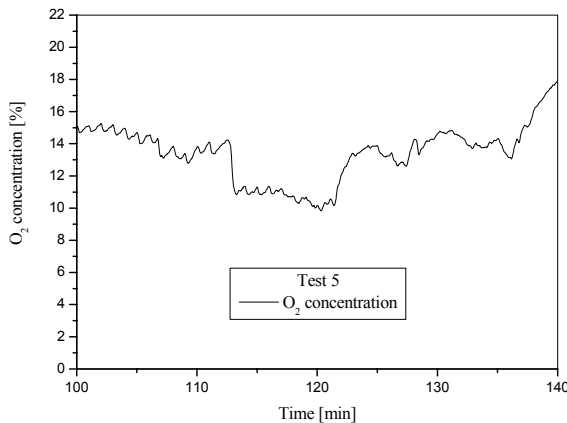

Figure 14. Test 5 – O₂ concentration

4. CONCLUSION

The boiler concept for combustion of large soya straw bales has been developed. In order to assess the combustion quality and to obtain data for the design of a soya straw-fired hot water boiler, a demo furnace has been designed, built and tested. Some conclusions, based on test results and on noted phenomena during the tests of the experimental facility, can be drawn.

Bale dimensions should be as uniform as possible and in accordance with the feeding channel diameter, in order to fill up the tube with fuel, which makes bale feeding easier. Bale quality should also be uniform, with respect to density and humidity. The bales should be stored in a way that keeps their form, and should be handled mechanically, by being pushed with hydraulic systems. One part of the feeding tube could be placed outside the boiler. Based on the appearance of the feeding tube near the furnace, which together with the results suggested that fire entered the tube, at least two bales must be in the process all the time, and this part of the feeding tube must be water-cooled. Good sealing must be secured in the feeding section as a whole.

In order to avoid unstable operation, the bale should “peek” over the furnace space very little during start-up. Start-up and achieving steady state should be done manually, and after that, steady operation should be maintained by automatic control.

Thermal power control is achieved by bale feeding control and by control of the active bale length inside the furnace. The control of the maximum temperature inside the furnace is done with the secondary air stream flowing towards the bale forehead. The rotation of the movable cross is necessary, for ash shaking-off and better distribution of secondary air. All elements for secondary air introduction must be well cooled with water. The tertiary air flow rate should be as low as possible.

Since the role of the secondary and the tertiary air is mainly to prevent the occurrence of high temperatures, a possibility of introduction of the re-circulated flue gas instead of secondary air should be taken into consideration. Although during all tests the temperature increased to over 850 °C at certain times, there were no problems with ash melting and deposition by sticking.

ACKNOWLEDGEMENTS

This work was supported by the Ministry of Science and Environmental Protection of Serbia, through the project PTR-2022B.

REFERENCES

- [1] Oka, S. and Jovanović, Lj.: Biomass in energy production, in: Oka, S. and Jovanović, Lj. (Eds.): *Biomass – a renewable energy source*, Yugoslav Society of Thermal Engineers – Institute of Nuclear Sciences “Vinča”, Belgrade, pp. 9-18, 1997, (in Serbian).
- [2] Oka, S. and Jovanović, Lj.: Combustion cycle and combustion lines of biomass, in: Oka, S. and Jovanović, Lj. (Eds.): *Biomass – a renewable*

energy source, Yugoslav Society of Thermal Engineers – Institute of Nuclear Sciences “Vinča”, Belgrade, pp. 25-28, 1997, (in Serbian).

- [3] Hellwig, M.: Basic of the combustion of wood and straw, in: Palz, W., Coombs, J. and Hall, D.O. (Eds.): *Proceedings of the 3rd E. C. Conference on Biomass “Energy from Biomass”*, 25-29.03.1985, Venice, pp. 793-798.
- [4] Obernberger, I.: Decentralized biomass combustion: State of the art and future development, *Biomass and Bioenergy*, Vol. 14, No. 1, pp. 33-56, 1998.
- [5] Nikolaisen, L.: Danish experience with straw combustion in district heating plants, in: *Proceedings of the COMETT Expert Workshop “Biomass Combustion”*, Joanneum Research, Graz, 1994.
- [6] Kristensen, E.F. and Kristensen, J.K.: Development and test of small-scale batch-fired straw boilers in Denmark, *Biomass and Bioenergy*, Vol. 26, No. 6, pp. 561-569, 2004.

NOMENCLATURE

T_1	temperature in the combustion zone [°C]
T_2	temperature in the zone above the bale [°C]
T_3	exit flue gas temperature [°C]

Greek symbols

λ	air excess coefficient
-----------	------------------------

КОТАО ЗА САГОРЕВАЊЕ ВЕЛИКИХ БАЛА СОЈИНЕ СЛАМЕ ЗА ГРЕЈАЊЕ ПЛАСТЕНИКА

**Растко Младеновић, Милијана Паприка, Мирко
Коматина, Александар Ерић, Милица
Младеновић, Драгољуб Дакић**

У једној од највећих компанија које се баве пољопривредном производњом у Србији под засадом соје се налази преко 2000 ha, и сваке године се произведе око 4000 t балиране сојине сламе. Планирано је да се сојина слама користи за грејање пластеника, укупне површине 5 ha. Због тога, у Лабораторији за термотехнику и енергетику Института за нуклеарне науке „Винча“ је учињен напор да се развије технологија за коришћење крупне балиране биомасе за производњу енергије. У првој фази, развијено је демонстрационо-експериментално постројење – ложиште за сагоревање бала сојине сламе. Ложиште је изграђено и термотехнички испитано, да би се утврдио квалитет сагоревања. Како су резултати испитивања били веома задовољавајући, у другој фази развоја, вреловодни котло сличних карактеристика (који сагорева бале сојине сламе димензија 0,7 x 1,2 x 2,7 m) је пројектован, и тренутно је у фази изградње.