

Dielectric Properties Modeling of Composite Materials

Mirko Dinulović

Assistant
University of Belgrade
Faculty of Mechanical Engineering

Boško Rašuo

Full Professor
University of Belgrade
Faculty of Mechanical Engineering

Tailoring dielectric properties of engineering materials has become very important since many radio wave propagation problems and remote sensing applications depend on correct values of these material properties. Prediction of material dielectric constant and loss tangent is of paramount importance. Polymer matrix composite materials are excellent candidates for these applications. In this paper analytical method for material dielectric constant and loss tangent prediction is presented. The model is experimentally verified for E-glass fibers embedded in epoxy matrix. Test results for 100 kHz to 1 MHz frequency range are presented.

Keywords: dielectric constant, loss tangent, E-glass/epoxy, polarization.

1. INTRODUCTION

The interaction between electromagnetic waves and dielectric materials is ruled by Maxwell equations over the whole frequency range [1]. These equations describe quantitatively how a time varying electric field is accompanied by a time varying magnetic field, and vice versa. Since both fields can cause energy storage and energy dissipation in the material, two sets of parameters are required to characterize a dielectric as a carrier of electromagnetic energy [2].

The complex permittivity, ϵ^* , can be considered a fundamental parameter for the macroscopic description of a dielectric exposed to the alternating fields. The concept of effective permittivity, or macroscopic dielectric constant, can be used to describe media that are homogeneous to the extent that scattering effects are insignificant as radio waves penetrate these materials. In radio wave propagation problems and remote sensing applications, the typical geophysical media is composed of materials with different dielectric properties. The use of effective permittivity in treatise of these problems has been proven to be very effective. This parameter can be measured and it can be expressed in terms of the constituent properties in experimental formulas.

Using a theoretical approach to assess the effective permittivity of dielectric mixtures requires the calculation of the polarizabilities and dipole moments of the inclusions that compose the mixture [3]. The dipole moments of simple discrete inclusions, like spheres and ellipsoids, can be expressed in closed form and the mixing formula for a two phase mixture can be derived. However, only for dilute suspensions is the mixing rule unique. Given the many degrees of freedom of a random medium for dense mixtures, it is plausible that many rivaling mixing formulas coexist [4-6].

The concept of effective permittivity focuses on mixtures where the inclusions are not seen as discrete

inclusions but rather the whole mixture is considered to be a continuous random medium.

The effective permittivity is a quality attributable to heterogeneous media. To be able to introduce this concept, the sizes of the inclusions have to be considerably smaller than the wavelength of the operating electromagnetic wave field [7].

2. MODELING DIELECTRIC CONSTANT AND LOSS TANGENT FOR E-GLASS/EPOXY COMPOSITE

The effective dielectric constant or the macroscopic permittivity, ϵ_{eff} , is defined as the ratio between the average displacement field \bar{D} and the average electric field \bar{E} :

$$\bar{D} = \epsilon'_{\text{eff}} \cdot \bar{E}. \quad (1)$$

A transversely isotropic fiber reinforced material has two principal dielectric constants: In fiber directions (called axial) designated as $\epsilon_{\text{eff-a}}$ and normal to the fibers, transverse, designated as $\epsilon_{\text{eff-T}}$. For fiber reinforced composite materials axial effective permittivity follows the rule of the mixtures and can be expressed as:

$$\epsilon_{\text{eff-a}} = \epsilon_{1a} \cdot f_1 + \epsilon_{2a} \cdot f_2. \quad (2)$$

In preceding equation effective permittivity (in fiber directions) is expressed as a function of axial dielectric properties of constituents which compose the mixture and their respected volume fractions in the composite.

Using the composite cylinder assemblage scheme, Hashin [8] derived the formulation for the effective dielectric constant in the direction normal to the fibers. The equation given in the terms of the properties and volume fractions of the constituents is expressed as:

$$\epsilon_{\text{eff-T}} = \epsilon_1 + \frac{f_2}{\frac{1}{\epsilon_2 - \epsilon_1} + \frac{f_1}{2 \cdot \epsilon_1}}, \quad (3)$$

where, index '2' refers to fiber properties and '1' is matrix constituent.

To construct the Composite Cylinder Assemblage model (CCA) one might consider a collection of

Received: June 2009, Accepted: July 2009

Correspondence to: Dr Mirko Dinulovic
Faculty of Mechanical Engineering,
Kraljice Marije 16, 11120 Belgrade 35, Serbia
E-mail: mdinulovic@mas.bg.ac.rs

composite cylinders, each consisting of a circular fiber core and a concentric matrix shell [9]. The sizes of outer radii of the cylinders may be chosen at will. The sizes of fiber cores radii is restricted by the requirement that in each cylinder ratio between radii be the same, which also implies that matrix and volume fractions are the same at each composite cylinder. It may be shown that for various loading of interest each composite cylinder behaves as a same equivalent homogeneous cylinder. A hypothetical homogeneous cylindrical specimen is assigned these equivalent properties and is progressively filled out with composite cylinders. Because the radii of the cylinders can be made arbitrarily small, the remaining volume can be arbitrarily small too. In the limit the properties of the assemblage converge to the properties of one composite cylinder. The construction of CCA is shown in Figure 1.

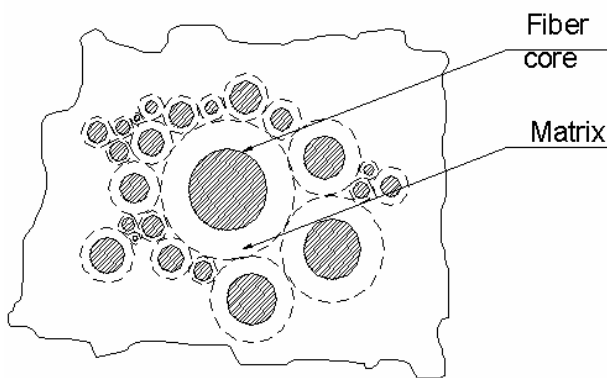

Figure 1. Composite cylinder assemblage model

A desirable feature of the model is the randomness of the fiber placement, and undesirable feature is the large variation of fiber sizes. Absolute bounds for composite mixtures for statistically isotropic two phase material are given by Wiener [10] and are derived in [11]. The bounds for effective permittivity of two phase composite model are given as:

$$\frac{1}{\frac{f_1}{\varepsilon_1} + \frac{f_2}{\varepsilon_2}} \leq \varepsilon_{\text{eff}} \leq f_1 \cdot \varepsilon_1 + f_2 \cdot \varepsilon_2, \quad (4)$$

where the bounds for effective dielectric constant are expressed as functions of dielectric constants constituents and their respective volume fractions in composite material.

2.1 Treatment of loss tangent

In order to characterize composite material as dielectric, predictions of the loss tangent are required. For most engineering materials, the loss per cycle is very small fraction of the total energy stored in the dielectric. Using this assumption Schulgasser [12] expressed the effective loss factor as linear combination of the loss factors of constituents that compose the composite material:

$$\varepsilon''_{\text{eff}} = \frac{\partial \varepsilon'_{\text{eff}}}{\partial \varepsilon_1} \varepsilon_1 + \frac{\partial \varepsilon'_{\text{eff}}}{\partial \varepsilon_2} \varepsilon_2. \quad (5)$$

This approach is applicable to low loss materials, that is $\tan \delta \ll 1$ [13]. The implication of the previous equation is as follows: For a composite material of some specific geometry, knowledge of the rate of change in constituent moduli is sufficient to determine the loss factor of the composite, assuming that the loss factors of constituents are known. Polymer-based composite materials are engineered dielectric materials for which dielectric constant remains constant (or it varies insignificantly) over a large frequency range while the loss factor changes substantially. For these materials derivatives in previous equation are not frequency dependant, and the assumption that effective loss factor is a linear combination of the loss factors of the constituents is valid.

Prager [14] has derived bounds on the derivatives for two phase statistically homogenous and isotropic dielectrics. When applied to low loss dielectrics the bounds can be expressed as:

$$\frac{1}{f_2} \left(\frac{\varepsilon'_{\text{eff}} - \varepsilon_1}{\varepsilon_2 - \varepsilon_1} \right) \leq \frac{\partial \varepsilon'_{\text{eff}}}{\partial \varepsilon_2} \leq \frac{\varepsilon'_{\text{eff}}}{\varepsilon_2} - \frac{\varepsilon_1}{\varepsilon_2 \cdot f_1} \left(\frac{\varepsilon_2' - \varepsilon'_{\text{eff}}}{\varepsilon_2 - \varepsilon_1} \right)^2$$

$$\frac{1}{f_1} \left(\frac{\varepsilon'_{\text{eff}} - \varepsilon_2}{\varepsilon_1 - \varepsilon_2} \right) \leq \frac{\partial \varepsilon'_{\text{eff}}}{\partial \varepsilon_1} \leq \frac{\varepsilon'_{\text{eff}}}{\varepsilon_1} - \frac{\varepsilon_2}{\varepsilon_1 \cdot f_2} \left(\frac{\varepsilon_1' - \varepsilon'_{\text{eff}}}{\varepsilon_1 - \varepsilon_2} \right)^2. \quad (6)$$

When the effective dielectric constant and the effective loss factor are known the effective loss tangent of the composite can be expressed as:

$$\tan \delta_{\text{eff}} = \frac{\varepsilon''_{\text{eff}}}{\varepsilon'_{\text{eff}}}. \quad (7)$$

With the bounds on derivatives and dielectric properties on constituents that compose the mixture, bounds on effective losses of composite material can be obtained.

3. EXPERIMENT

The epoxy polymer matrix based on epichlorohydrin and bisphenol A (DER 324 by D.O.W chemicals) was used as a starting material. Curing agent was cycloaliphatic amine (Ancamine 2167 by Air products). For this system the recommended curing agent to resin ratio was 28 to 100 by weight, and this ratio was used to produce matrix samples. Curing profile for this system was 2 h at 80 °C and 3 h at 149 °C.

To determine the density of the cured matrix samples ASTM specification D792-86 was followed. The density of DER 324 epoxy cured with Ancamine 2167 was experimentally obtained, and the average sample density was 1.16 g/cm³. Determining the density of the samples as per D792 standard consists of specimen weight measurement in the air and the fully immersed specimen in the distilled water. The density of the sample can be expressed as a function of the sample weight in the air, sample weight when fully immersed in the distilled water and the weight of

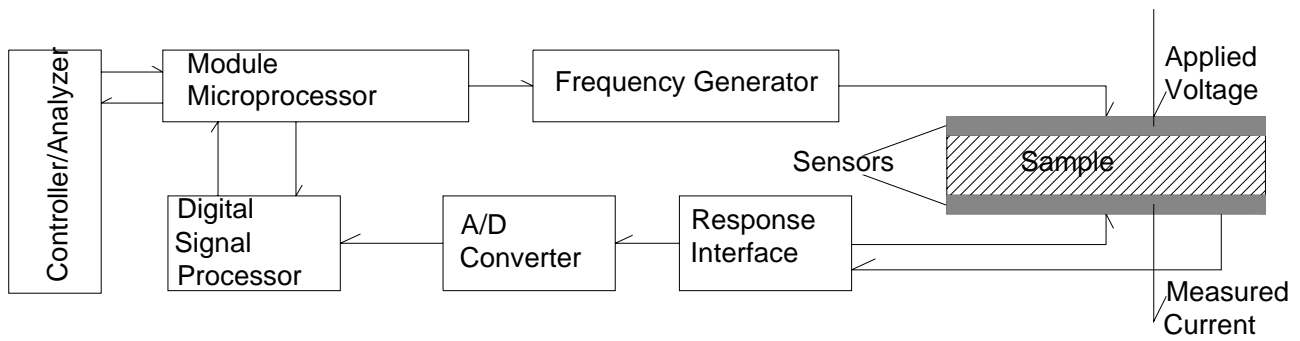

Figure 2. DEA 2970 Dielectric Analyzer – schema

partially immersed attachment (usually wire) that was used to hold sample while the measurements for the fully immersed sample were taken. The density of the sample is given by following relation:

$$\rho_c = \frac{a}{a - w + b} \cdot 0.9975 \quad (8)$$

where:

- ρ_c – density of the composite specimen,
- a – weight of the specimen in the air,
- b – weight of fully immersed specimen into the distilled water and
- w – weight of the partially immersed attachment.

These samples were subjected to dielectric tests in the 100 Hz to 100 kHz range, at room temperature and normal humidity using the dielectric analyzer DEA 2970 in the parallel plate mode (Fig. 2).

Measured dielectric data for composite phases, for the frequency range of interest is given in Tables 1 and 2.

Table 1. DER 324 dielectric properties

DER 324	Dielectric constant	$\tan \delta$
100 Hz	3.32	0.0050
1 kHz	3.29	0.0083
10 kHz	3.11	0.0144
100 kHz	3.20	0.0212

Manufacturing of the samples which consisted of DER 324 epoxy matrix and E-glass fibers plain weave (J.B. Martin) was done by using the hand lay-up technique [15]. The density of the fiber mat was obtained experimentally, and it was determined to be 2.54 g/cm^3 , based on the samples from three different batches of this material. This was necessary in order to determine the fiber volume fraction of the E-glass/epoxy samples. Manufactured samples had a fiber volume fraction of 30 to 40 %. Curing profile for these samples was the same as for the DER 324 matrix without fibers. The dimension of the E-glass/epoxy samples before dielectric measurement was $25 \times 25 \text{ mm}$ and 1.5 mm thick. These samples were subjected to dielectric tests at 100 Hz to 100 kHz range at room temperature and normal humidity, using the DEA 2970 dielectric analyzer (Fig. 2). Dielectric data for E-glass fibers is presented in Table 2.

Table 2. E-glass dielectric properties

E-glass	Dielectric constant	$\tan \delta$
100 Hz	2.51	0.0135
1 kHz	2.49	0.0060
10 kHz	2.40	0.0034
100 kHz	2.50	0.0045

Composite material under investigation, with constituent phases is presented in the following picture, Figure 3.

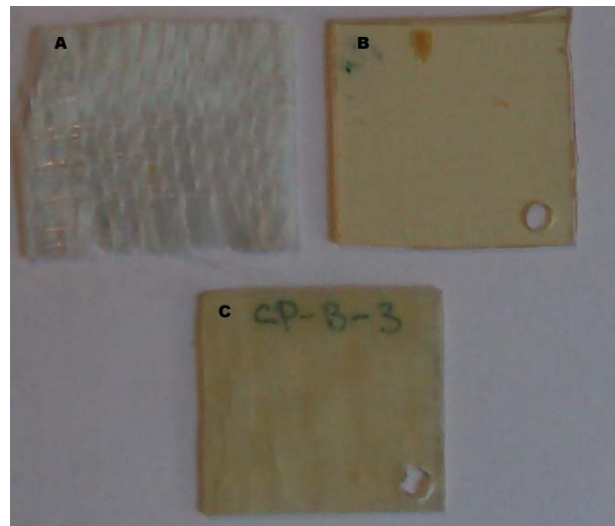

Figure 3. Composite material samples: (a) E-glass fibers, (b) epoxy matrix and (c) epoxy – E-glass composite

The SEM micrograph for manufactured composite samples is given in Figure 4.

3.1 Experimental results

Experimentally obtained dielectric properties data, dielectric constant and loss tangent of epoxy – E-glass composite material in 100 Hz to 100 kHz frequency range and for 30 to 40 % fiber volume fraction are presented in the following figures (Figs. 4 to 12). Calculated dielectric values, based on developed analytical composite dielectric model are graphically presented using solid line, whereas measured dielectric data are presented using solid dots, for frequency range and composite volume fractions of interest.

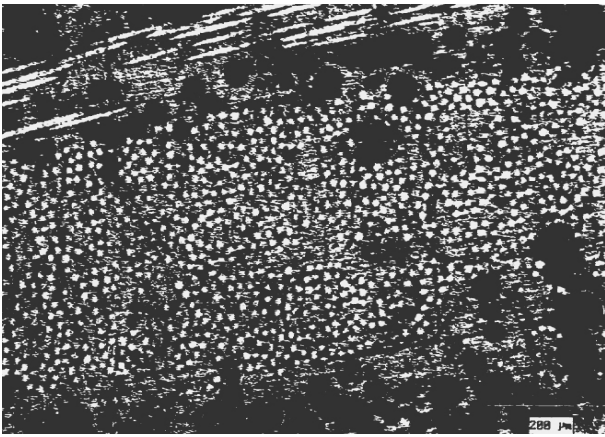

Figure 4. Epoxy – E-glass composite micrograph (37 % Vf)

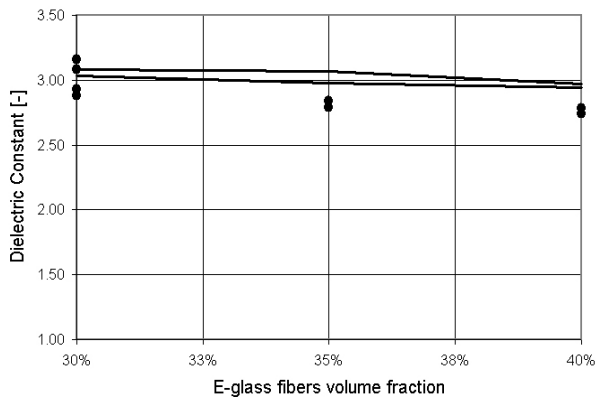

Figure 5. Dielectric constant, 100 Hz, epoxy – E-glass

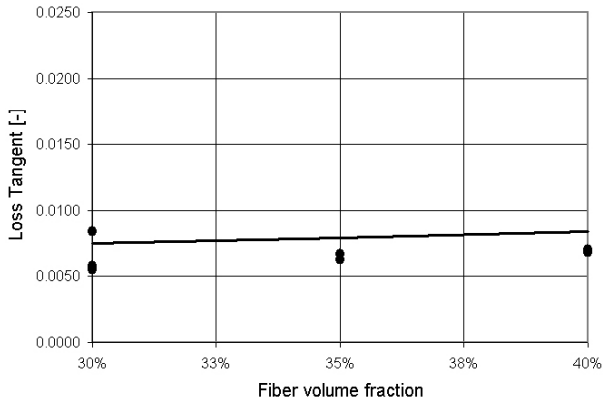

Figure 6. Loss tangent, 100 Hz, epoxy – E-glass

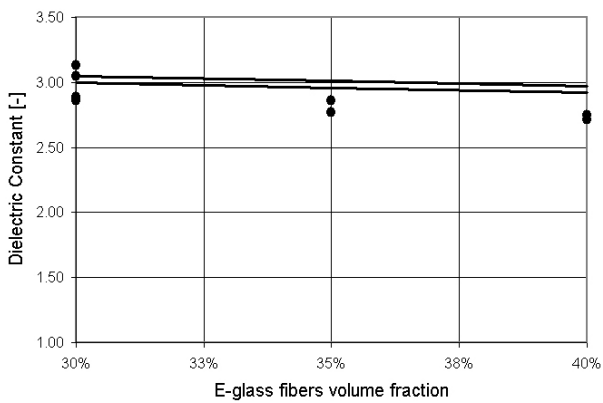

Figure 7. Dielectric constant, 1 kHz, epoxy – E-glass

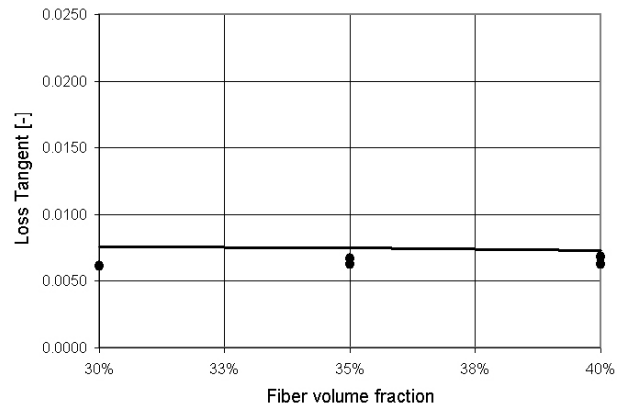

Figure 8. Loss tangent, 1 kHz, epoxy – E-glass

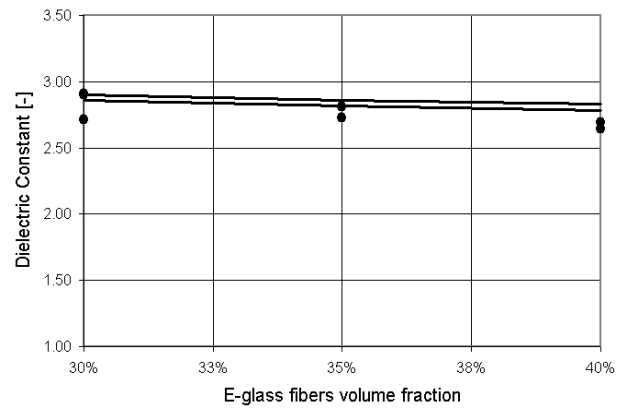

Figure 9. Dielectric constant, 10 kHz, epoxy – E-glass

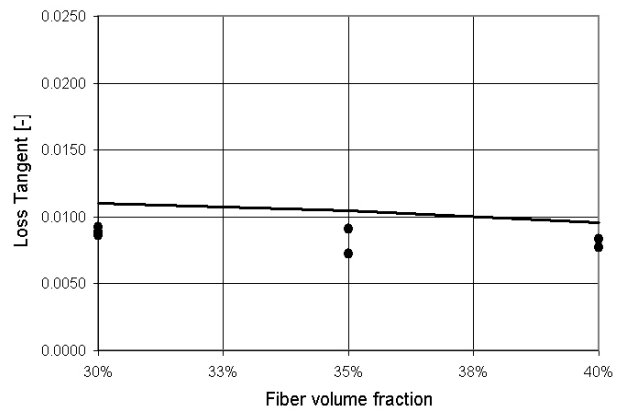

Figure 10. Loss tangent, 10 kHz, epoxy – E-glass

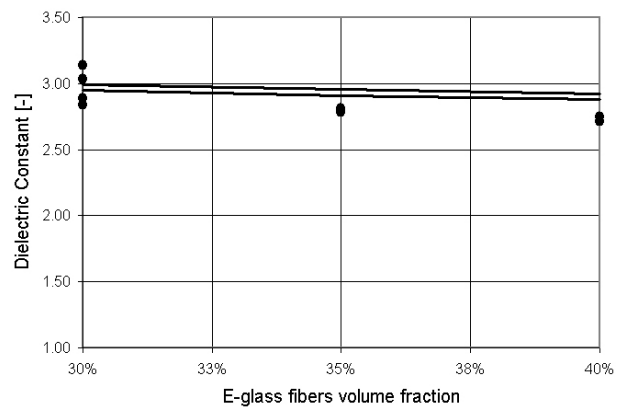

Figure 11. Dielectric constant, 100 kHz, epoxy – E-glass

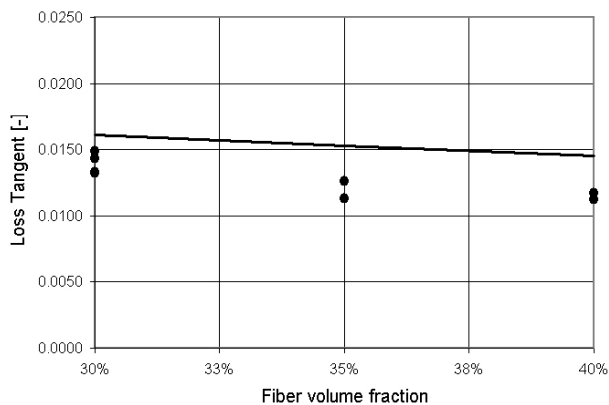

Figure 12. Loss tangent, 100 kHz, epoxy – E-glass

4. CONCLUSION

Material dielectric properties can be successfully tailored using different materials having distinct dielectric values. Predicting dielectric constant and loss tangent of multiphase material is of great importance for radio propagation and remote sensing applications. New analytical model based on equations proposed by Prager and Wiener is formulated, and experimentally verified. The frequency dependent parameters of composite constituents (epoxy matrix and E-glass fibers) were experimentally obtained and taken as input for analytical dielectric model. This was done for composite system with varying fiber to matrix volume ratio. The calculated dielectric properties were compared with experimentally obtained data. It's been found that epoxy – E-glass composite system can be used to obtain material with exact values of dielectric constant and loss tangent. Variation of fiber volume fraction in this material system highly influences the dielectric properties of the composite system. Dielectric model proposed predicts lower values for dielectric material properties (loss tangent and dielectric constant) for higher fiber volume ratios. For lower fiber volume fractions (below 30 % Vf) it is not conclusive which bound yields better results, and further investigation is required.

ACKNOWLEDGMENT

The authors are grateful to Concordia University in Montreal, Canada, for the use of composite materials laboratory where all experimental measurement was performed. Also, to the companies J.B. Martin and D.O.W chemicals for providing necessary samples for composites manufacturing.

REFERENCES

- [1] Böttcher, C.F.: *Theory of Electric Polarisation*, Elsevier, Amsterdam, 1973.
- [2] Aspens, D.E.: Local-field effects and effective-medium theory: A macroscopic perspective, *American Journal of Physics*, Vol. 50, No 8, pp. 704-709, 1982.
- [3] Sareni, B., Krähenbühl, L., Beroual, A. and Brosseau, C.: Effective dielectric constant of

periodic composite materials, *Journal of Applied Physics*, Vol. 80, No. 3, pp. 1688-1696, 1996.

- [4] Schen, L.C., Liu, C., Korringa, J. and Dunn, K.J.: Computation of conductivity and dielectric constant of periodic porous media, *Journal of Applied Physics*, Vol. 67, No. 11, pp. 7071-7081, 1990.
- [5] Tuncer, E., Serdyuk, Y.V. and Gubanski, S.M.: Dielectric mixtures: electrical properties and modeling, *IEEE Transactions on Dielectrics and Electrical Insulation*, Vol. 9, No. 5, pp. 809-828, 2002.
- [6] Serdyuk, Y.V., Podoltsev, A.D. and Gubanski, S.M.: Numerical simulations of dielectric properties of composite material with periodic structure, *Journal of Electrostatics*, Vol. 63, No. 11, pp. 1073-1091, 2005.
- [7] Hill, R.: A self-consistent mechanics of composite materials, *Journal of Mechanics and Physics of Solids*, Vol. 13, No. 4, pp. 213-222, 1965.
- [8] Hashin, Z.: Assessment of the self consistent scheme approximation: conductivity of particulate composites, *Journal of Composite Materials*, Vol. 2, No. 3, pp. 284-300, 1968.
- [9] Richard, T.G.: The mechanical behavior of a solid microsphere filled composite, *Journal of Composite Materials*, Vol. 9, No. 2, pp. 108-113, 1975.
- [10] Finzel, M.C., Hawley, M.C. and Jow, J.: Dielectric properties of a curing epoxy/amine system at microwave frequencies, *Polymer Engineering and Science*, Vol. 31, No. 16, pp. 1240-1244, 1991.
- [11] Liu, J.G. and Wilox, D.L.: Dielectric mixture model for a hollow-ceramic-sphere composite, *Journal of Applied Physics*, Vol. 77, No. 12, pp. 6456-6460, 1995.
- [12] Shulgasser, K. and Hashin, Z.: Bounds for effective permittivities of lossy dielectric composites, *Journal of Applied Physics*, Vol. 47, No. 2, pp. 424-427, 1976.
- [13] Clauzon, P., Krähenbühl, L. and Nicolas, A.: Effective permittivity of 3D lossy dielectric composite materials, *IEEE Transactions on Magnetics*, Vol. 35, No. 3, pp. 1223-1226, 1999.
- [14] Prager, S.: Bounds on the derivatives for two phase statistically homogeneous and isotropic non lossy dielectric, *Journal of Chemical Physics*, Vol. 50, No. 3, pp. 4305-4311, 1969.
- [15] Rasuo, B.: *Aircraft Production Technology*, Faculty of Mechanical Engineering, Belgrade, 1995, (in Serbian).

МОДЕЛИРАЊЕ ДИЕЛЕКТРИЧНИХ КАРАКТЕРИСТИКА КОМПОЗИТНИХ МАТЕРИЈАЛА

Мирко Динуловић, Бошко Рашуо

Компоновање материјала са аспекта диелектричних карактеристика је постало веома важно у циљу

задовољења целокупних захтева конструкција, нарочито код проблема који се тичу простирања радио таласа кроз различите средине. Композитни материјали на бази полимерних матрица представљају одличне кандидате за овакве примене. У овом раду представљен је модел диелектричних особина композитног материјала, на основу којег је могуће предвидети вредности диелектричне константе и диелектричних губитака композитног материјала

полазећи од диелектричних карактеристика фаза које сачињавају композитни систем.

У експерименталном делу рада, измерене су диелектричне карактеристике композитног материјала на бази епоксидне матрице са стакленим влакнима, различитог волуметријског односа и резултати упоређени са резултатима предложеног модела. Сва испитивања изведена су у фреквентном опсегу од 100 kHz до 1 MHz.