

Constant Volume Combustion Cycle for IC Engines

Jovan Dorić

Assistant
University of Novi Sad
Faculty of Technical Sciences

Ivan Klinar

Full Professor
University of Novi Sad
Faculty of Technical Sciences

Marko Dorić

PhD student
University of Novi Sad
Faculty of Agriculture

This paper presents an analysis of the internal combustion engine cycle in cases when the new unconventional piston motion law is used. The main goal of the presented unconventional piston motion law is to make a realization of combustion during constant volume in an engine's cylinder. The obtained results are shown in PV (pressure-volume) diagrams of standard and new engine cycles. The emphasis is placed on the shortcomings of the real cycle in IC engines as well as policies that would contribute to reducing these disadvantages. For this paper, volumetric efficiency, pressure and temperature curves for standard and new piston motion law have been calculated. Also, the results of improved efficiency and power are presented.

Keywords: constant volume combustion, IC engine, kinematics.

1. INTRODUCTION

Internal combustion engine simulation modelling has long been established as an effective tool for studying engine performance and contributing to evaluation and new developments. Thermodynamic models of the real engine cycle have served as effective tools for complete analysis of engine performance and sensitivity to various operating factors [1-4]. During its 135 years long history, a reciprocating four stroke piston internal combustion engine has evolved in a very mature thermal machine which has excluded all the alternatives offered for motor vehicle's drive. The main goal of its further development is to harmonize the growing traffic with environmental and energy consumption. The four stroke SI engine is a widely applied power source in transportation and other power generation units. In some areas IC engines are so dominant without concurrence of other types of engines. However, the construction of conventional internal combustion engines is based on inefficient thermodynamic and mechanical concept. Only 12.6 % of original energy from the fuel conversion to the wheels provides acceleration, overcomes aerodynamic drag and rolling resistance [5]. The rest is lost, therefore because of this the potential to improve fuel economy with advanced technologies is enormous. Even modern internal combustion engines convert only one third of the energy in fuel into useful work. The rest of the energy is lost to waste heat, the friction of moving engine parts or to pumping air into and out of the engine. One of the main causes for such low efficiency of these engines is related to process and way of heat addition in IC engines. A study of gas cycles as the models of internal combustion engines is useful for illustrating some of the important parameters influencing engine performance. As is well known, the constant volume heat addition cycle, which is often referred to as the Otto cycle, considers one special case

of an internal combustion engine, whose combustion is so rapid that the piston does not move during the combustion process, and thus combustion is assumed to take place at constant volume [6]. Although in theoretical terms heat addition takes place at constant volume, in real engine cycle heat addition at constant volume can not be performed. The main reason for this is relatively simple kinematics of IC engines, which provides continuously piston movement during the rotation of the crankshaft. So in the real engine heat addition occurs during a variable volume, and this results in reduced efficiency.

In this paper, an unconventional piston motion law which provides smooth stop, dwell and go movement of the piston has been simulated. In this way, heat addition can occur during constant volume in a real engine process.

2. OTTO CYCLE

2.1 Air standard Otto cycle

An air standard Otto cycle model is shown in Figure 1. The compression process is an isentropic process 1-2; the heat addition is an isochoric process 2-3; the expansion process is an isentropic process 3-4; and the heat rejection is an isochoric process 4-1. As is usual in finite time thermodynamic heat engine cycle models we suppose two instantaneous adiabatic processes 1-2 and 3-4.

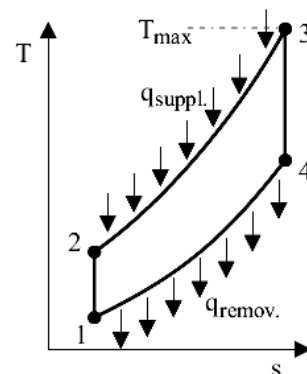

Figure 1. TS diagram for the air standard Otto cycle

Received: April 2011, Accepted: July 2011
Correspondence to: Jovan Dorić M.Sc.
Faculty of Technical Sciences,
Trg Dositeja Obradovića 6, 21000 Novi Sad, Serbia
E-mail: jovan_d@uns.ac.rs

Also, the same cycle can be shown in another more appropriate diagram, where changes in volume and pressure in relation to heat addition and heat rejection can be easily seen. A PV diagram of the air standard Otto cycle is shown in Figure 2.

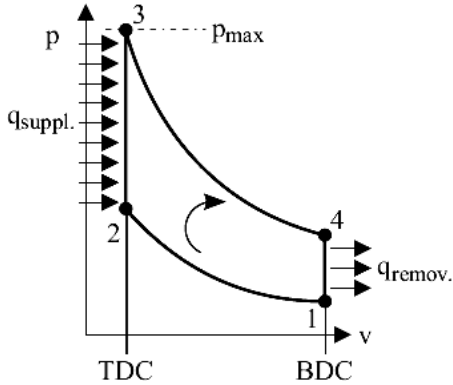

Figure 2. PV diagram for the air standard Otto cycle

The constant-volume process is thermodynamically efficient and, in principle, a feasible cycle. In contrast to the Carnot process, it avoids isothermal expansion and compression and the unrealistically high pressure ratio. It consists of two isentropes and two isochores. It is called a constant-volume process because the heat supply (instead of combustion) ensues in constant space, i.e. under constant volume. Because the piston moves continuously, the heat supply would have to occur infinitely fast, i.e. abruptly. However, that is not realistically feasible. For the thermal efficiency of this process follows:

$$\eta_t = 1 - \frac{q_{\text{removed}}}{q_{\text{supplied}}} = 1 - \frac{C_v(T_4 - T_1)}{C_v(T_3 - T_2)} = 1 - \frac{T_1}{T_2} \frac{T_4 - 1}{T_3 - 1} \quad (1)$$

2.2 Real engine cycle

The real engine cycle of an SI four stroke engine can be illustrated by mapping the pressure-volume (PV) data extracted from a pressure trace. As the cylinder volume is a function of the crank angle, it is possible to relate the cylinder pressure to cylinder volume and thus construct a PV diagram as seen in Figure 3.

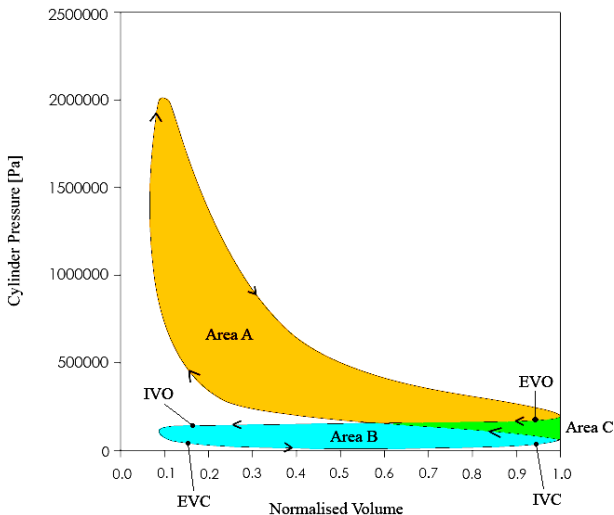

Figure 3. PV diagram for a four stroke SI engine

Typical valve events such as intake valve open (IVO), intake valve close (IVC), exhaust valve open (EVO) and exhaust valve close (EVC) are shown in the diagram along with the direction indicators to clarify the process. The area under the curve is the indicated work per cycle as given by the (2) where p is the cylinder pressure and V is the cylinder volume.

$$\frac{W}{\text{cycle}} = \int p dV \quad (2)$$

From Figure 3 it can be seen that there are three distinctive areas known as Area A, Area B and Area C. The integral over the exhaust and intake strokes (Area B + Area C) is the indicated work done on the gas by the piston. This is known as pumping indicated work. On the other hand, the integral over the compression and power strokes (Area A + Area C) is the indicated work done onto the piston by the gas. This is known as gross indicated work. The work generated throughout the entire cycle is then known as the net indicated work. Note that work out of the system is negative and work into the system is positive. It is evident from Figures 2 and 3 that there are drastic differences between ideal and theoretical cycles. One of the reasons for these differences is related to the kinematics of the piston mechanism. The differences between the conventional and unconventional kinematics will be described in the sections below.

3. KINEMATICS OF CONVENTIONAL IC ENGINE

Movement of the piston in conventional IC engines is based on relatively simple kinematics [7,8]. Figure 4 shows the kinematics of a crankshaft drive with crossing, in which the longitudinal crankshaft axis does not intersect with the longitudinal cylinder axis, but rather is displaced by the length e .

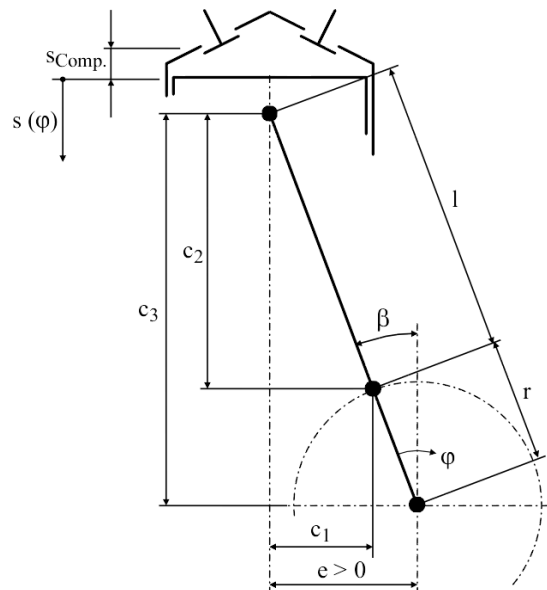

Figure 4. Kinematics of the crankshaft drive

For the piston path $s(\varphi)$, it follows from Figure 4.

$$s(\varphi) = c_3 - c_2 - r \cos(\varphi - \beta) \quad (3)$$

from which with

$$\sin \beta = \frac{e}{r+l} \text{ and } \beta = \arcsin\left(\frac{e}{r+l}\right), \quad (4)$$

respectively

$$\begin{aligned} c_1 &= e - r \sin(\beta - \varphi) \\ c_2 &= \sqrt{l^2 - c_1^2} \\ c_3 &= \sqrt{(r+l)^2 - e^2} \end{aligned} \quad (5)$$

finally

$$s(\varphi) = \sqrt{(r+l)^2 - e^2} - \sqrt{l^2 - [e + r \sin(\varphi - \beta)]^2} - r \cos(\varphi - \beta). \quad (6)$$

The derivative provides for the piston speed the relation:

$$\frac{ds}{d\varphi} = r \sin(\varphi - \beta) + \frac{r[e + r \sin(\varphi - \beta)] \cos(\varphi - \beta)}{\sqrt{l^2 - [e + r \sin(\varphi - \beta)]^2}}. \quad (7)$$

From the definition of the cylinder volume:

$$V(\varphi) = V_C + D^2 \frac{\pi}{4} s(\varphi) \quad (8)$$

the alteration of cylinder volume follows in (9):

$$\frac{dV}{d\varphi} = D^2 \frac{\pi}{4} \frac{ds}{d\varphi}. \quad (9)$$

With the eccentric ratio of crank radius and connecting rod length $\lambda = r/l$, it follows for the limiting case when $e = 0$.

$$s(\varphi) = r \left\{ [1 - \cos(\varphi)] + \frac{1}{\lambda_k} \left[1 - \sqrt{1 - \lambda_k^2 \sin^2(\varphi)} \right] \right\}. \quad (10)$$

Through this kinematics, the movement of the piston is very limited, refer to (10), the piston is not able to make a dwell, but only changes the direction of the movement. It can be seen that dwell exists only for an infinitesimal moment.

4. UNCONVENTIONAL PISTON MOVEMENT

In this section, the new unconventional piston motion law will be presented. With this movement, the piston is able to make such motion where heat addition can be done during piston dwell. The IC engine mechanism that can allow such unconventional motion will not be presented in this paper, since it is not the authors' intention to propose a new internal combustion engine design.

The design geometry creates a pause or dwell in the piston's movement at the TDC (top dead center) and the BDC (bottom dead center), while the output shaft continues to rotate for up to 20 degrees. Adding these constant volume dwell cycles improves fuel burn, maximizes pressure, and increases cylinder charge. Fuel burn can be precisely controlled by maintaining a minimum volume (TDC piston dwell) throughout the burn process. Containment maximizes pressure and burn

efficiency. Furthermore, holding the piston at maximum volume (BDC piston dwell) provides additional time for the cylinder to fully charge before closing the intake valves. The design creates unconventional four stroke cycle process. This unconventional cycle consists of the following strokes and processes:

The first stroke consists of forced and free intake. During the forced intake, piston travels from TDC to BDC, which draws fresh mixture into the cylinder. This part of the stroke is the same as the intake stroke in the ordinary IC engines. The second part is the free intake. After the piston comes into BDC, it stops there for a while. This dwell time depends on the optimization of the intake process and it will not be explained in detail in this paper. However, it is very important that the piston dwell does not last longer or shorter than the optimal calculated value. After the piston comes into BDC, the column of fresh gases continues to flow into the cylinder by inertia, until the intake valve closes. In this way the intake volumetric efficiency is increased.

The second stroke consists of the compression process and a combustion during constant volume. In the first part of this second stroke, the piston travels from BDC to TDC. The ignition occurs at TDC without any spark advance, thus saving the accumulated energy of the flywheel. Ignition begins when the piston is stopped at the TDC, while the piston stop lasts for the time calculated by optimisation to complete combustion and prevent any back-pressure caused by the spark advance. Consequently, the use of energy obtained from the fuel is maximized and the fuel consumption is decreased.

The third stroke is an expansion stroke, during which the piston comes from TDC to BDC like in a standard mechanism but with the exception that piston again makes a dwell in BDC. In this new unconventional four stroke cycle, the entire expansion stroke occurs between TDC and BDC. Compared to standard IC engine, in the new piston motion movement there is no exhaust valve opening advance, which determines loss of possibly resulting work. In the second part of this third stroke, the piston comes on BDC and stays in the same position for a while. During this time high-pressure gases are spontaneously evacuated, while the piston is stopped at the BDC.

The last stroke is exhaust stroke, during which the exhaust gas is actually a low pressure gas, so the piston will not require a big pumping effort going up towards TDC. In the last phase of exhaust stroke, exhaust gases can freely leave compression volume. At the same time intake valves slowly open and fresh charge comes into the cylinder, while the piston is still in the dwell mode at TDC. Previously described unconventional four stroke cycle can be illustrated by Figure 5.

The similarity with the standard piston path is evident. The piston dwells can be seen in the Figure 5. In this case, 20 degree dwells were chosen for both TDC and BDC. This value improves combustion and cylinder charging, respectively.

Figure 6 shows standard piston movement for the next selected parameters:

- $r = 60$ mm;
- $l = 200$ mm;
- $e = 0$ mm.

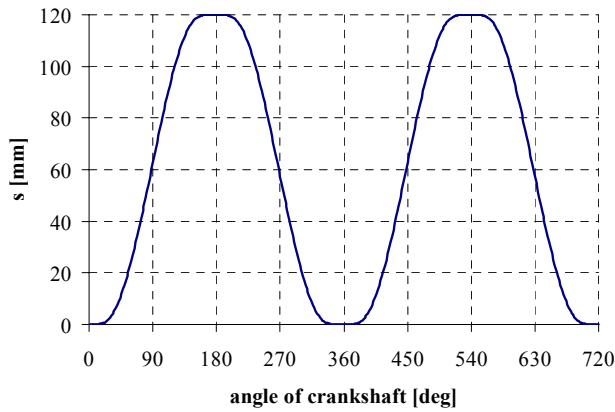

Figure 5. Piston path for new four stroke cycle

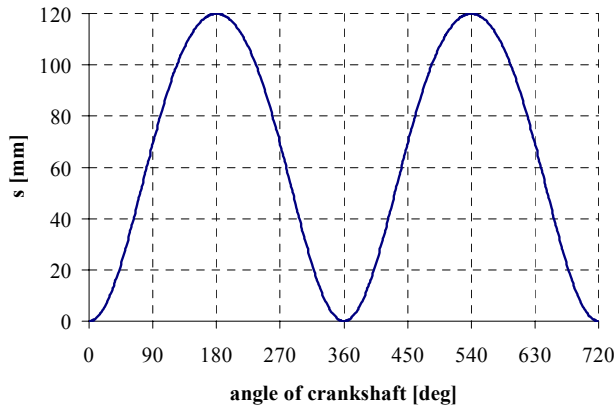

Figure 6. Piston path in conventional IC engine

The following figure (Fig. 7) presents a comparison of both piston motion laws, showing all the differences and similarities of two different approaches to solving the piston movement problems, i.e. volume changing in IC engine cylinder.

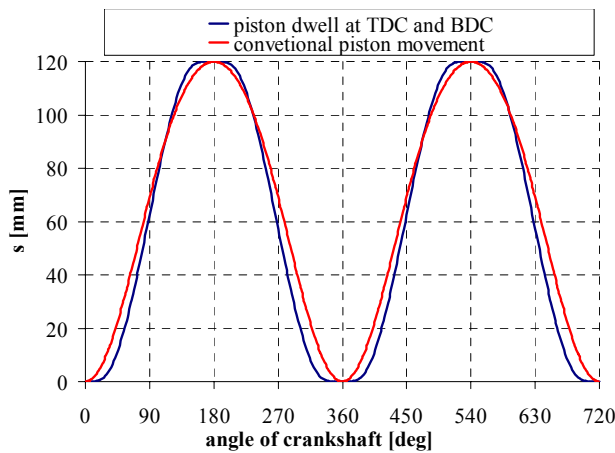

Figure 7. Comparison of standard and new four stroke cycles

5. CYCLE MODEL

The details of the flow (as calculated in the flow network of both engine models) are obtained as a solution of quasi-one-dimensional compressible flow equations governing the conservation of mass, momentum and energy. The flow network of both conventional and unconventional piston movement is discretized into a series of small volumes and the governing equations are then written in a finite

difference form for each of these elementary volumes. A staggered mesh system is used, with equations of mass and energy solved for each volume and the momentum equation solved for each boundary between volumes. The equations are written in an explicitly conservative form as:

Equation (11): mass continuity equation

$$\frac{dm}{dt} = \sum_{\text{boundaries}} m_{\text{flux}} \cdot \quad (11)$$

Equation (12): Conservation of momentum equation

$$\frac{d(m_{\text{flux}})}{dt} = \frac{dpA + \sum_{\text{boundaries}} (m_{\text{flux}}u)}{dx} - \frac{4C_f \frac{\rho u^2 dx A}{2D} - C_p \left(\frac{1}{2} \rho u^2 \right) A}{dx} \quad (12)$$

Equation (13): Conservation of energy equation

$$\frac{d(m e_n)}{dt} = p \frac{dV}{dt} + \sum_{\text{bound.}} m_{\text{flux}} H - h_g A (T_{\text{gas}} - T_{\text{wall}}) \quad (13)$$

If the engine cylinder element has one zone, the entire cylinder is treated as one region. In the latter, the cylinder is divided into two regions (unburned and burned), which share a common pressure. The two-zone model is used to capture the chemical processes taking place during the combustion period in more detail. Combustion models may be used either with a single or two-zone engine cylinders, but for this research two zone models were used. For the single zone model there is the energy equation, refer to (14), as below:

$$\Delta(mu) = \sum_{i=1}^n m_i h_i - Q - P \Delta V \quad (14)$$

During combustion, the only term of enthalpy flow is $\Delta m_i h_i$ due to propagation of the flame front to the unburned zone. For the two-zone, refer to model (14), in the unburned zone we have:

$$m_{u1} u_{u1} - m_{u0} u_{u0} + P(V_{u1} - V_{u0}) + Q_u - \Delta m_{ui} h_{ui} = 0 \quad (15)$$

Using the equation of the state, it becomes:

$$m_{u1} u_{u1} - m_{u0} u_{u0} + m_{u1} R_{u1} T_{u1} - P V_{u0} + Q_u - \Delta m_{ui} h_{ui} = 0 \quad (16)$$

Similarly, for the burned zone we have:

$$m_{b1} u_{b1} - m_{b0} u_{b0} + m_{b1} R_{b1} T_{b1} - P V_{b0} + Q_b - \Delta m_{bi} h_{bi} = 0 \quad (17)$$

As a constraint, the volumes of the unburned and burned zones are summed up to the total cylinder volume:

$$m_{u1} R_{u1} T_{u1} + m_{b1} R_{b1} T_{b1} - P V_c = 0 \quad (18)$$

The last three equations are a complete set and are solved by using the Newton iteration method.

Within the automotive industry the most widely adopted technique for gas exchange studies is to solve the one-dimensional coupled set of non-linear equations using the finite volume or finite difference method. This technique is used in several commercial softwares e.g., Ricardo/WAVE, GT-Power and AVL/BOOST. In this paper, Ricardo/WAVE software was used, which provides a fully integrated treatment of time-dependent fluid dynamics and thermodynamics by means of one-dimensional formulation. Since this article investigates the unconventional piston motion, classical approach to solving the problems of volume changes cannot be applied. When the piston position differs from standard crank piston motion, the imposed piston motion sub-model can be used for modelling the engine. The formulation to calculate the instantaneous cylinder volume is identical to the one used in the standard WAVE model, with the exception that the piston position, s , is linearly interpolated between points in the user-entered profile. Smooth piston motion depends on the fine spacing of the crank angle array. In this case arrays large enough were used to enable one-degree spacing. As far as the high-pressure part of the cycle is considered, the most important process is the combustion. In this program, the Ricardo Wave model of combustion can be selected between several options, ranging from theoretical models with constant volume or constant pressure heat release, over Viebe-function based heat release models, to quasidimensional two-zone model of turbulent flame propagation. The SI Viebe function is widely used to describe the rate of fuel mass burned in thermodynamic calculations [9]. This relationship allows the independent input of function shape parameters and of burn duration. The experimentally observed trends of premixed SI combustion are represented quite well. In this paper, the Viebe one-stage model of heat release has been chosen. The parameters of Viebe function were selected to achieve good agreement between modelled and experimentally recorded pressure. The selected parameters have been successfully applied in the research [10-12]. The cumulative mass fraction burned as a function of crank angle is given by the following equation:

$$W = 1 - \exp(-AWI(\theta / BDUR)^{(WEXP+1)}) \quad (19)$$

where: AWI is internally calculated parameter to allow $BDUR$ to cover the range of 10 – 90 %, θ is degrees past start of combustion, $BDUR$ is combustion duration (10 – 90 %), and $WEXP$ is exponent in Viebe function.

For the both cases was chosen law of fuel combustion refer to Figure 8.

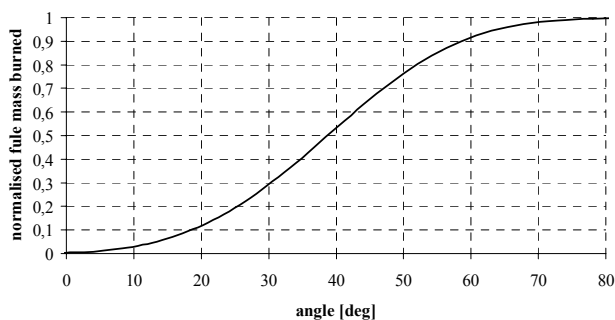

Figure 8. Normalised fuel mass burned

6. RESULTS

The following parameters from Table 1 have been selected for this analysis.

Table 1. Main engine data

Swept volume [l]	2.71	
Bore/stroke [mm/mm]	120/120	
Compression ratio [-]	10	
Number of valves per cylinder	4 (2 inlet and 2 exhaust)	
IVO – inlet valves opens [CA° before TDC]	with dwell	without dwell
	0	10
$IVDUR$ – inlet valves open duration [deg]	230	240
Inlet valves diameter [mm]	44	44
EVO – exhaust valve opens [CA° before BDC]	48.5	41
$EVDUR$ – exhaust valves open duration [deg]	235	232
Exhaust valves diameter [mm]	40	40

It is observed from Table 1 that some parameters are different for these two approaches for realisation of the IC engine cycle. One of the main reasons for different values is in relation to different piston movement, i.e. different length of compression and expansion cycles. Also, the start of combustion for these two cases is different; because of the piston dwell in TDC with the proper ignition time it is possible to avoid negative work.

PV diagram of conventional IC engine was shown in Figure 9.

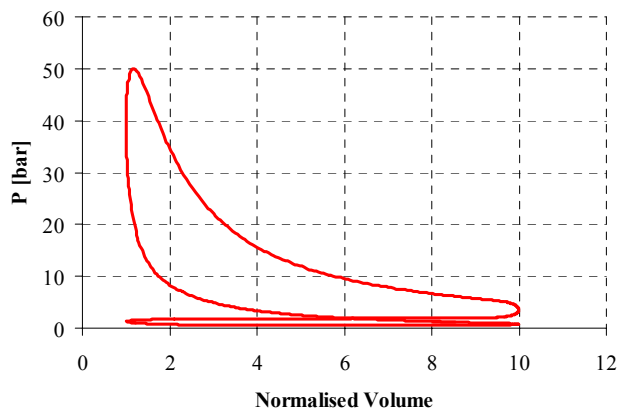

Figure 9. PV diagram of conventional IC engine

Now, it is interesting to see how this unconventional motion with piston dwell in BDC and TDC has an impact on pressure changes in relation to cylinder volume. Such PV diagram is shown in the next figure (Fig. 10), where is obvious that this new piston motion allows different changes of the working fluid. First, it can be concluded that in this case adding heat has been done by increasing the constant volume portion of combustion, i.e. more constant volume combustion. Also, there is no rising of pressure due to combustion before TDC, and negative work has been eliminated in this new concept. This feature is a consequence of piston dwell in TDC. Both PV diagrams were solved for the cases when engine operates at 2000 rpm at full throttle.

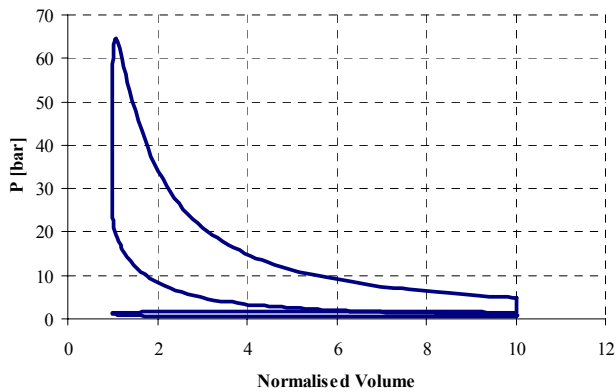

Figure 10. PV diagram due piston dwell in TDC and BDC

Besides this very important fact about a new concept, there are some other advantages over the standard PV diagram. If we look at the end of the expansion stroke, it is evident that expansion occurs between TDC and BDC, where the exhaust valve opens when the piston stops in TDC. In this way, the area of PV diagram is increased, and for the same heat input it means more efficiency. Also, the pressure at the beginning of the exhaust stroke is smaller than in conventional engines, so with this new four stroke movement pumping work is lower.

Now, we can compare these two approaches. This comparison is shown through the graph in Figure 11.

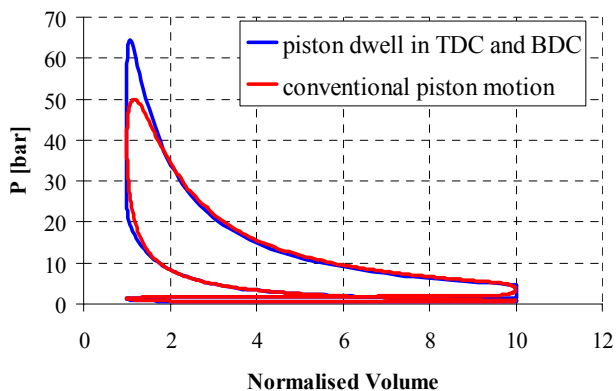

Figure 11. Comparison of standard and new four stroke cycles in PV diagram

The impact of unconventional piston motion on volumetric efficiency and power of engine was presented through Figures 12 and 13.

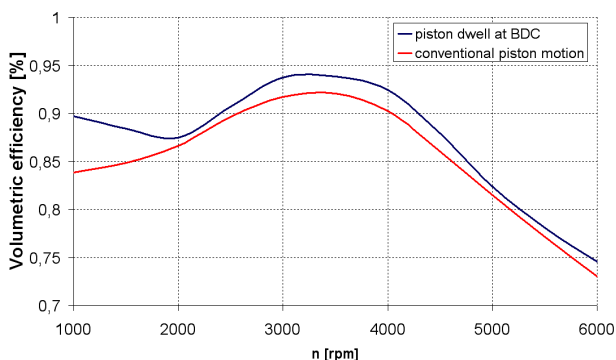

Figure 12. Comparison of volumetric efficiency

One of the important aspects of each heat engine is the temperature of exhaust gases. As can be seen from Figure 14 unconventional kinematics allows lower

temperatures of products of combustion at the end of the expansion stroke.

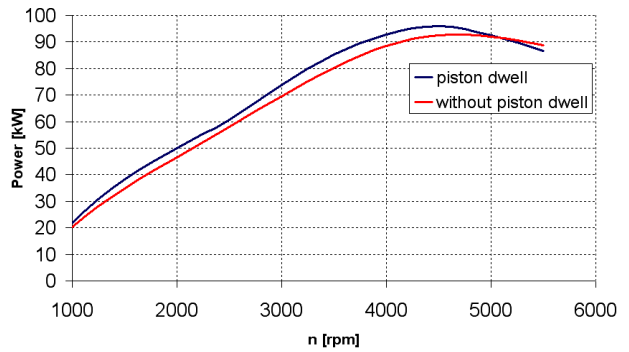

Figure 13. Comparison of power

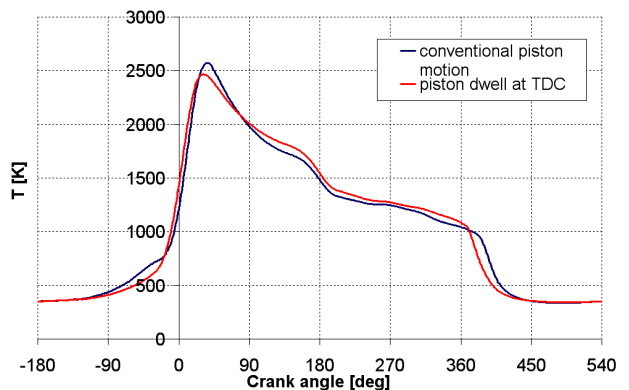

Figure 14. Comparison of temperature during working process

Efficiency curves for the full throttle conditions have also been performed for this analysis. These results can be seen in graph from Figure 15.

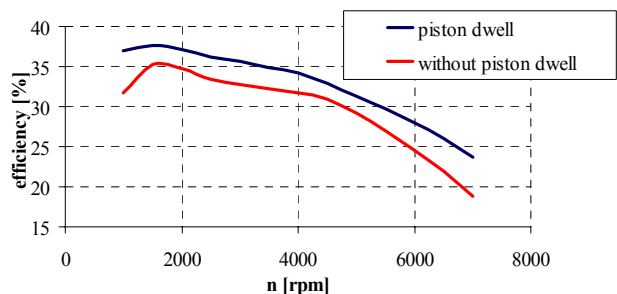

Figure 15. Comparison of efficiency curves

It can be concluded that with this new kinematics of IC engine there is an efficiency improvement of about 11 % at full throttle.

7. CONCLUSION

In this paper, a new four stroke cycle for internal combustion engines was analyzed. The main purpose of this new cycle is to increase the engine efficiency. The essential challenges in developing this procedure are the control of the start of combustion, and proper selection of *IVDUR*, *EVDUR*, *IVO* and *EVO*. Improvement in the efficiency is achieved through unconventional kinematics of piston movement, as a result of more favourable heat input and lower pumping work. The goal of new motion is to achieve smooth stop, dwell and go movement in real engine cycle. Simulation on the basis of quasi one-dimensional modelling was performed to obtain PV

diagrams, temperatures and efficiency curves under full throttle for standard and new piston motion. From the results described in Figures 13 and 15 it can be concluded that piston dwells in TDC and BDC have significant impact on engine performances. The volumetric efficiency is a measure of the ability of an engine to induct air into its cylinders. Maximizing the volumetric efficiency is always a high priority. With piston dwell in BDC, high pressure of fresh gases in the beginning of compression stroke can be achieved. Also, with piston dwell in TDC it is possible to realize more constant volume combustion.

The automobile industry is under large pressure to keep developing automobiles with IC engines, to reduce fuel consumption and exhaust gas emissions, as well as to seek better alternatives for vehicle drive. In this article, one of the possible alternatives for conventional internal combustion engine cycle which contributes to increasing efficiency has been presented.

ACKNOWLEDGMENT

This work was supported by Projects TR35041 and TR31046 of the Serbian Ministry of Science.

REFERENCES

- [1] Heywood, J.B.: *Internal Combustion Engine Fundamentals*, McGraw-Hill, New York, 1988.
- [2] Horlock, J.H. and Winterbone, D.E.: *The Thermodynamics and Gas Dynamics of Internal Combustion Engines, Vol. II*, Oxford University Press, New York, 1986.
- [3] Moran, M.J. and Shapiro, H.N.: *Fundamentals of Engineering Thermodynamics*, Wiley, New York, 2000.
- [4] Rakopoulos, C.D. and Giakoumis, E.G.: Second-law analyses applied to internal combustion engines operation, *Progress in Energy and Combustion Science*, Vol. 32, No. 1, pp. 2-47, 2006.
- [5] Mahlia, T.M.I., Saidur, R., Memon, L.A., Zulkifli, N.W.M. and Masjuki, H.H.: A review on fuel economy standard for motor vehicles with the implementation possibilities in Malaysia, *Renewable and Sustainable Energy Reviews*, Vol. 14, No. 9, pp. 3092-3099, 2010.
- [6] Zhaoa, Y. and Chen, J.: An irreversible heat engine model including three typical thermodynamic cycles and their optimum performance analysis, *International Journal of Thermal Sciences*, Vol. 46, No. 6, pp. 605-613, 2007.
- [7] Merker, G.P., Schwarz, C., Stiesch, G. and Otto, F.: *Simulating Combustion*, Springer-Verlag, Berlin, 2006.
- [8] Dorić, J. and Klinar, I.: Kinematic analysis of piston mechanism in valveless internal combustion engine with more complete expansion, in: *Proceedings of the International Congress Motor Vehicles & Motors 2010*, 07-09.10.2010, Kragujevac, Serbia, pp. 397-405.
- [9] Tomić, M. and Petrović, S.: Spark ignition engine part load fuel economy improvement: Numerical consideration, *FME Transactions*, Vol. 31 No. 1, pp. 21-26, 2003.
- [10] Schaerlaeckens, W.P.M. and Deckers, R.J.H.: The application of WAVE in the early stages of engine design, NedCar Technology, Helmond, Holland, available at: http://www.ricardo.com/Documents/Downloads/pdf/wave_early_stages.pdf
- [11] Golubev, P.A., Mironychev, M.A. and Nesterenkov, A.M.: Application of the WAVE system at the initial stages of engine design, OJSC "ZMZ", Russia, available at: http://www.ricardo.com/Documents/Downloads/pdf/wave_initial_stage_design.pdf
- [12] McCollum, D.L., Thornton, M.J. and Taylor, J.D.: Application of WAVE 1-D engine models with vehicle simulation tools to investigate efficiency, performance, and emission impacts of advanced engine operation, *Presented at the Ricardo Software 9th Annual International Users Conference*, 13.03.2004, Southfield, USA, available at: http://www.ricardo.com/Documents/Downloads/pdf/wave_1d_engine_models.pdf

NOMECLATURE

C_V	specific heat under constant volume
D	cylinder diameter
e	eccentricity
e_n	energy
H	enthalpy
h	specific enthalpy
h_g	heat transfer coefficient
l	connecting rod length
m	mass
n	number of revolution per minute
P	pressure
Q	heat
R	universal gas constant
r	crankshaft radius
s	piston path
t	time
u	specific internal energy
V	volume
x	coordinate

Abbreviations

AWI	internally calculated parameter to allow BDUR to cover the range of 10 – 90 %
BDUR	combustion duration
EVDUR	exhaust valves open duration
EVO	exhaust valve opens
IVDUR	inlet valves open duration
IVO	inlet valves opens
WEXP	exponent in Viebe function

Greek symbols

β	angle
Δ	difference
ε	compression ratio
η_t	thermal efficiency
θ	degrees past start of combustion
λ_k	rod relation
π	number (≈ 3.1415)
ρ	density

φ angle of crankshaft

Subscripts

- 1 gas state at the beginning of compression
 - 2 gas state at the end of compression
 - 3 gas state at the beginning of expansion
 - 4 gas state at the end of expansion
 - b burnt gas
 - c chamber
 - u unburnt gas
-

**САГОРЕВАЊЕ ПРИ КОНСТАНТНОЈ
ЗАПРЕМИНИ КОД МОТОРА СУС**

Јован Дорић, Иван Клинар, Марко Дорић

У овом раду је представљена анализа радног циклуса мотора са унутрашњим сагоревањем за случај коришћења неконвенционалног закона кретања клипа. Главни циљ истраживања описаног неконвенционалног кретања клипа је реализација сагоревања при константној запремини. Добијени резултати су приказани преко PV (притисак-запремина) дијаграма стандардног и новог циклуса. Акцент је стављен на недостатке реалног циклуса као и на правце развоја који ће допринети редуковању ових недостатака. У раду је извршена анализа степена пуњења, притиска и температуре за стандардни и нови закон кретања клипа, при чему резултати показују повећање ефикасности и снаге.