

Analytical and Numerical Method of Velocity Fields for the Explosively Formed Projectiles

Olivera Jeremić

Associate Professor
University of Belgrade
Faculty of Mechanical Engineering

Momčilo Milinović

Full Professor
University of Belgrade
Faculty of Mechanical Engineering

Milos Marković

Teaching Assistant
University of Belgrade
Faculty of Mechanical Engineering

Boško Rašuo

Full Professor
University of Belgrade
Faculty of Mechanical Engineering

The current paper presents analytical and numerical approaches of velocity performances estimations for the EFP (Explosively Formed Projectiles). The proposed analytical methods mathematically develop velocities parameters of a particular segment for EFP liner propelled by explosive process. This model is based on the well-known theoretical approaches of energy distribution on plastic body in dynamical conditions providing integral solution for projectile final velocity. The redundant to analytical, the numerical method is also developed, to provides estimations about behavior of projectile vs. time in the EFP forming process powered by explosion. Both models are valid for performances estimations of EFP warheads and design data for optimal EFP configuration. Simulations are supported by the software Matlab and Autodyn for analytical and numerical modeling respectively. The obtained numerical and analytical results are compared with the available experimental data.

Keywords : *explosively formed projectiles, analytical method, numerical simulation, velocities distribution.*

1. INTRODUCTION

Nowadays, the EFP warheads are present in many systems that expect appropriate modernization and/or optimization; as artillery sub-munitions, antitank missiles, mines etc. An approaches which define the processes of explosively formed projectiles [1-4] are one of the most sophisticated problems of rigid body mechanics based on the elastic to plastic theory. The distinguishing problem of the EFP projectiles is the velocity of the EFP liner. This velocity is generated in the explosively driven process and the dynamics of their evolution is the main topic of this paper. Recently, most papers are based on numerical methods [5-10] which determine the projectiles velocity performances based on detailed modeling of the loadings and deformation process during explosion. Numerical software, particularly Autodyn, which are often used for detailed analyses in numerical simulations, require comprehensive preparation of the expected initial data but some others methods as it analytical are less precise but enough reliable and provides much faster data obtaining for the applications of warheads performances estimations.

The current paper presents a software based on the analytical method as a solution to provide the ability to preliminarily estimations as well as numerical solution of the same rooted liners velocities. Further this methodology provides ability to analyze the adopted design of warhead's performances by more precise

numerical software, Autodyn.

The research based on the analytical models presented in this paper as well as in papers [1-5], provides crucial information about the EFP performances in a short time without required comprehensive initial data preparation.. The algorithm provides the possibility to directly export the adopted geometry of EFP liners integrated with warheads into Autodyn numerical software, from the software package Matlab, which considerably decreases preparation time.

Two analytical models presented in papers [1, 2, 3] are integrated in this paper. The first model [1] is based on the active explosive charge masses, which, as the charges, corresponds to grid elements, to force explosively driven liners' elements. The result of this model is to integrate the explosively process in the initial EFP velocity calculation. The second model [2] is based on Gurney's *method* [11], for the final EFP velocity estimations. This method particularly uses axial and radial direction approach of the active explosive charge masses for each element in liner's grid. These final estimations of radial and axial plastic energy distributions, as stated in the paper [2], present invariant expressions to be used for the form estimations influenced on the final velocities of EFP in the initial phase.

The results of analytical and numerical methods contribute in improving the accuracy of EFP velocity estimations. This is achieved by an appropriate augmentation in the number of the grid elements for the both methods differently.

2. CALCULATION METHODS

The aim of this section is to present analytical and numerical approach and to verify their comparative results as well as through the comparison with available experimental data.

Received: May 2016, Accepted: August 2016

Correspondence to: Olivera Jeremić
Faculty of Mechanical Engineering,
Kraljice Marije 16, 11120 Belgrade 35, Serbia
E-mail: ojeremic@mas.bg.ac.rs

doi:10.5937/fmet1701038J

© Faculty of Mechanical Engineering, Belgrade. All rights reserved

FME Transactions (2017) 45, 38-44 38

2.1 Analytical approach

The adopted analytical model is based on explosive masses, energy and momentum balance equations to estimate initial EFP velocity. The semi-spherical liner position 1 is divided into n observed elements that start from its axis of symmetry. In addition, full cylindrical volume of the explosive charge, position 2, fig 1, is also divided in the same manner. Each element of liner corresponds to the amount of explosive segment shaped by ϵ_i and orientated perpendicular to the surface of the liner and located above it (Figure.1). By the liner's partition in elementary grids, fig 1 position 1, and by accepting that the detonation pressure of explosive products attacks each particular element on the grid, the impulses and momentum exchanges, and final liner's velocity can be summarized [1]. The initial velocities of these elements depend not only on their position on the liner, but also on liner's geometry. For further analysis, the following assumptions are accepted:

- Detonation products attack metal liner immediately.
- The motion of each discrete element of metal liner is along the radius of liner and there are no crossing effects between grid elements.
- The constant tensile strain rate along axis is ($\dot{\epsilon}_{0zi} = const$) provides that there is no stretching of elements.

Using previous assumptions and energy balance equation in detonation process, the velocity of a particular ejected element on the liner's grid, V_{0i} [1] is equal to:

$$V_{0i0} = D \sqrt{\frac{1}{k^2 - 1} \frac{3\beta_i}{3 + \beta_i}}; i = 1, 2, \dots, n \quad (1)$$

where $\beta_i = m_{ai} / M_i$, is the *loading factor* of i -th liner's element, m_{ai} - active mass of corresponding explosive segment, M_i - mass of liner's i -th segment, M_i - mass velocity and M_i - mass coefficient of detonation products, usually taken as $k=3$ [1].

The active mass of the explosive m_{ai} in the *loading factor*, in equation (1), is a fictive explosive mass that reproduces all effects of energies made by real explosive masses and covers. Corresponding expression for this mass is [1],

$$m_{ai} = \frac{m_i}{2} \left(1 + \frac{M_{Ki} - M_i}{M_i + M_{Ki} + m_i} \right); i = 1, 2, \dots, n, \quad (2)$$

or

$$m_{ai} = \frac{m_i^2}{2(M_i + m_i)} \text{ for } M_{Ki} = 0 \quad (3)$$

used in the cases with (2) or without (3) warhead covers.

Values m_i are the masses of explosive segments and M_{Ki} are the masses of metal cover segments. The idea in this paper is to verify the analytical method implemented in software for several types and geometries of EFP, and compare velocity results with the available experimental results.

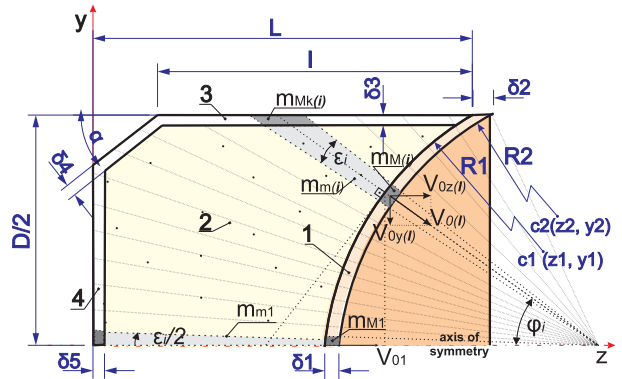

Figure 1: Adopted geometry of EFP warhead for analytical analyses; 1- liner, 2- explosive charge, 3- case, 4- back plate; Input parameters: D-caliber, L-length of charge, I-starting cone position, δ_1 -thickness of liner center, δ_2 -thickness of liner edge, δ_3 -thickness of cover, δ_4 -thickness of back plate, α -angle of cone, R1-inner radius, R2-outer radius [3]

The differences between kinetic energies of elements correspond to the plastic deformation work along z-axis [1, 5, 11] as the consequence of the relative motion towards liner's mass center. The expression that represents the energy of axial deformation work is [2]:

$$A_{DE} = \frac{1}{2} \left[\sum_{i=1}^n M_i (V_{0i} \cos \varphi)^2 - \sum_{i=1}^n M_i V_{0E}^2 \right] \quad (4)$$

$$i = 1, 2, \dots, n$$

The improved methodology considers contribution of the radial deformation energy, plastic deformation work which corresponds to the part of kinetic energy created by radial displacement of the elements. This radial deformation work is presented by the kinetic energy of radial velocity values of each element, $V_{0i} \cos \varphi_i$ [1, 5, 11] and it is given in [2] as follows:

$$R_{DE} = \frac{1}{2} \sum_{i=1}^n M_i (V_{0i} \sin \varphi)^2; i = 1, 2, \dots, n. \quad (5)$$

The final velocity of the EFP is performed by integrating all absolute velocities of liner's elements from the equation (1), and particular masses, by momentum conservation law. It is given by the following expression [1, 2 and 11]:

$$V_{0E} = \frac{\sum_{i=1}^n V_{0i} M_i}{\sum_{i=1}^n M_i}; i = 1, 2, \dots, n. \quad (6)$$

The algorithm, shown as a flow chart on figure 2, significantly contributes in analyzing and evaluating the affecting parameters on EFP main performances. Using variations in inputs, the algorithm provides enough precise output data such as axial initial velocity of EFP liner as well as kinetic energies distributed in axial and radial directions.

The algorithm offers the possibility to choose various EFP configurations by varying the geometries and the used materials, in addition to the number of segments to be used, as presented by the block (a) fig. 2.

After approving the 3D visual model of the EFP by the designer (block (b)), the algorithm computes the masses and the volumes of each segment referring to the Gulden's theorem and based on the inputs.

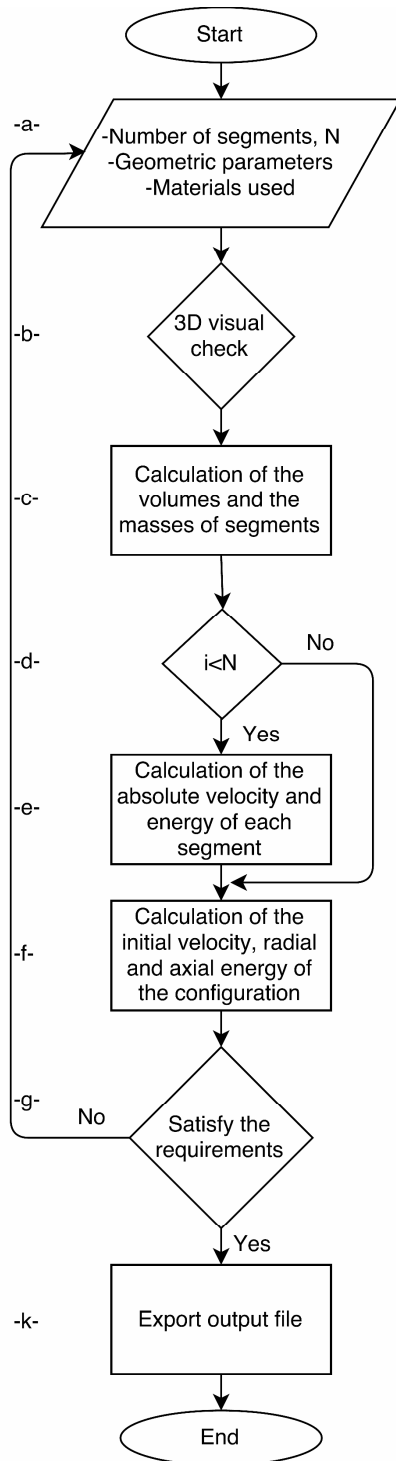

Figure 2: Algorithm for calculating EFP performances

The volumes of segments for the linear, the explosive as well as the case are calculated in block (c) following the next steps: firstly, the area of each segment is calculated by double integral, where the intervals of integration are defined by the segment' boundaries. Secondly, the distance traveled by each segment is computed in function of the coordinate of the centroid and the angle of revolution, which is equal to 2π . Finally, the volume of each segment, which

is generated by its rotation about an axis of revolution, is equal to the product of its area and the distance traveled by its geometric centroid.

After that, the algorithm calculates the absolute velocity of each segment using equation (1), in block (e) and controlled by block (d). Then, the initial velocity of the configuration as well as the kinetic energies distributed in axial and radial directions is calculated by equations (4), (5) and (6) respectively in block (f). Finally, the designer has the ability to export output data from analytical simulation, in block (k). In case that the results do not respect the system requirements, the simulation process can be reinitiated with new inputs.

2.2 Numerical approach

Numerical approach based on the finite element method is also used in this investigation in order to be compared with experimental data.

The properties of the adopted simulation model mesh [12-19] are given in Table 1. The mesh density is determined taking into account accuracy as well as reasonable simulation run time within available computer facilities.

Figure 3a and 3b shows configuration of EFP warhead as well as appearance of created mesh for each component separately.

The simulation sample volume in numerical approach is observed as the quarter shown on the figure 3a and 3b.

Presented analysis uses fully Lagrangian solver, where after $35 \mu s$, detonation products are not influenced into forming proceses. But that average liners final velocity comparative with analytical modeling corresponds not to the $35 \mu s$ instant of forming time then about $70-150 \mu s$ where dynamical process is fully completed (figures 9 and 10).

Table 1: Grid properties of the numerical approach [3]

Conditions	Type 1		Type 2*	
	1	2	1	2
Liner	7776	6125	7776	6125
Explosive	10496	9000	10496	9000
Cover	15006	12000	-	-
Back plate	768	450	768	450

1 – nodes; 2 –elements;

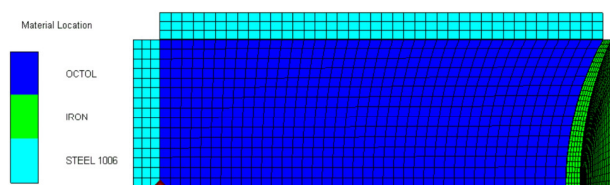

Figure 3a: Geometrical configuration of EFP sample type1 (with cover) and finite elements mesh

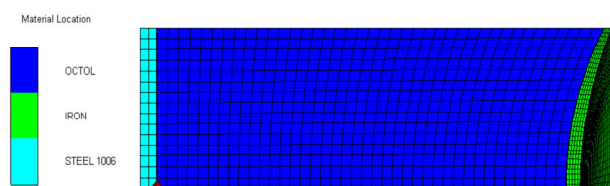

Figure 3b: Geometrical configuration of EFP sample type2 (without cover) and finite elements mesh

The loading forces distribution model is expressed by the detonation pressure products and is determined according to Jones-Wilkins-Lee [1] by the equation of state:

$$p = K \left(1 - \frac{\omega}{R_1 V} \right) e^{(-R_1 V)} + K_1 \left(1 - \frac{\omega}{R_2 V} \right) e^{(-R_2 V)} + \frac{\omega E}{V} \quad (7)$$

where V and E are represented as $V = \rho_0 / \rho$, $E = \rho_0 e$, ρ_0 is the current density, ρ is the reference density, e is the specific internal energy and K, K_1, R_1, R_2 and ω are constants for the given explosive material [1,2].

3. SIMULATION MODEL

The comparison of these methods is performed on the sample design fig 4, with accepted, fixed EFP liner form and explosive charge, with and without metal cover. Adopted explosively driven projectile model and its elements of geometry, presented in the paper [2], and design characteristics of testing sample as in the [14] are shown in Fig. 4 The model does not include the fuze and wave shaper integrated in the warhead design and influenced on the real performances modeling.

The properties of explosive and other materials used in simulations are given in Table 1 [14]. In tested examples, the initiation point is located on the warhead bottom and lies on axis of symmetry [14] (Fig. 1).

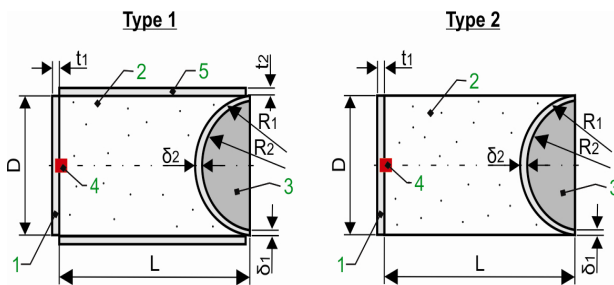

Figure 4: Types of testing sample and their basic dimensions: 1-back plate, 2-explosive charge, 3-liner, 4-initiation point, 5-cover

Table 2: Geometrical parameters for EFP sample models [3]

Design parameter		Type 1	Type 2*
Length of charge	L [mm]	85	85
Caliber	D [mm]	57.2	57.2
Thickness of back plate	t1 [mm]	5	3
Cover thickness	t2 [mm]	5	-
Inner radius	R1 [mm]	60.4	71.3
Outer radius	R2 [mm]	60.4	71.3
Thickness of liner edge	$\delta 1$ [mm]	1.5	1.5
Thickness of liner center	$\delta 2$ [mm]	2.7	2.7
Type initiation		p.	p.
* -experiment; p. -point initiation			

Analytical and numerical approach used Octol as explosive material with density of 1.82 g/cm³ and detonation velocity 8480 m/s as well as steel as cover and iron as liner material. The experimental sample was tested on the proving ground as a type 2 [14] in Table 2.

4. RESULTS AND DISCUSSION

Two types of simulation samples of the liners and explosives integrated have been considered through represented modeling in analytical and numerical approaches.

Figures 5 and 6 show velocity distribution of observed elements along the liner for sample type 1 with metal cover and back plate and type 2 without cover element obtained by both models analytical and numerical.

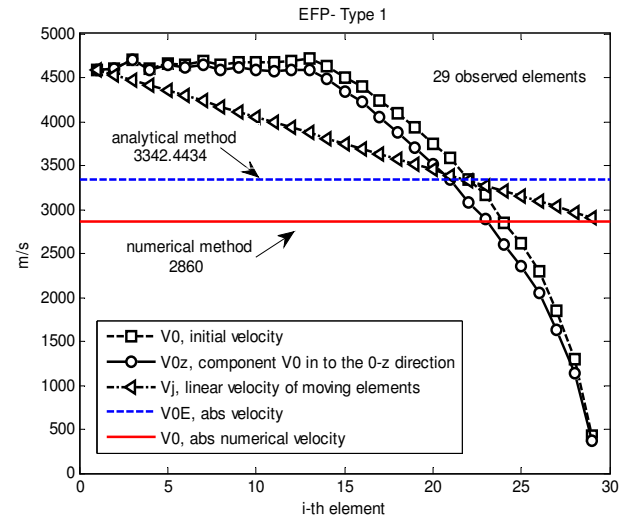

Figure 5: Velocity distribution along the liner obtained with analytical and numerical method presented with square, circle and triangle. Straight lines show absolute values of velocity (type1) [3]

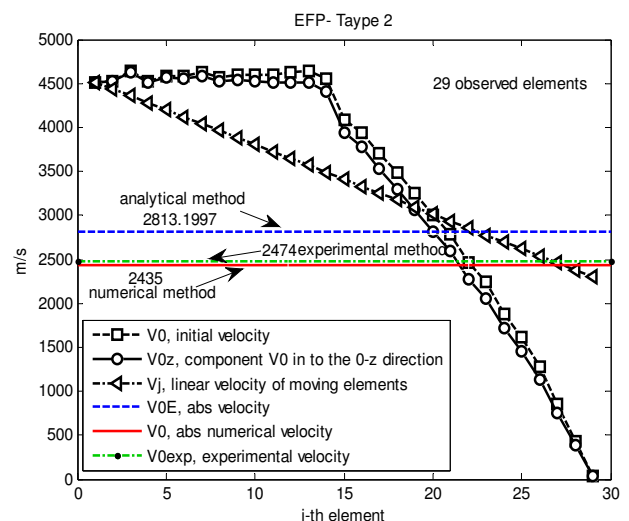

Figure 6: Velocity distribution along the liner obtained with analytical and numerical method presented with square, circle and triangle. Straight lines show absolute values of velocity (type2) [3]

Line marked with squares fig 5 and 6 represents absolute velocities of rejected liner segments at initial time and line marked with circles represents component of absolute velocity along the direction of motion (z-axis). 14 elements observed from the central line have approximately linear both absolute and component velocities profiles. Further 15 elements have nonlinear velocity distribution.

According to analytical method (4), as shown on Figs. 5 and 6, the final velocity of projectile mass center is 3342.44 m/s for the type 1 and 2813.12 m/s for the sample type 2.

Comparing numerical method velocity value of 2860 m/s for type 1 with obtained analytical values, the relative error is ~15%, which could be considered as referent.

For sample type 2, both models are comparing with the experimental one [14], for which experimental data are available. Calculated velocity by the analytical method for this sample type is 2813.12 m/s; comparing with experimental of about 2474 m/s [14], corresponding to the differences of about 13%. Velocity obtained by numerical calculations is 2435 m/s and comparing with experimental value of 2474 m/s makes error of 1.5%. This confirms that the numerical method is much more reliable but also more expensive for the simulation.

Nonlinear descent of velocities' profiles after the 14th edged element (Figs. 5 and 6) in the analytical approach is influenced by the decrease of active mass, (loading factor for corresponding elements) regarding smaller mass of appropriate explosive charge in the model. The axial velocity distribution is responsible for the appropriate shaping of projectile after explosion. This approves analytical model as the initial tool for design and analysis of projectile shape and dynamics in the initial phase of design.

Figures 7 and 8 show energy distribution vs. time during projectile forming. Kinetic energy, represents penetration capability of formed projectiles.

The plastic works, is important for liners' design and for selection of appropriate material. Figure 7 and 8 represents nonlinear and uniform distribution of plastic energy. It means that liner during formation had proper deformation also influenced on the velocities distribution. If that curve in initial phase of formation have no permanent increase, this indicates the liner had the fracture.

Table 3 shows differences in the energy distribution obtained by the numerical and analytical approach. In table 3 are presented next values: absolute initial velocity V_0 [m/s], kinetic energy E_k [J], axial deformation energy ADE [J], radial deformation energy RDE [J] and plastic deformation energy/plastic work PW [J].

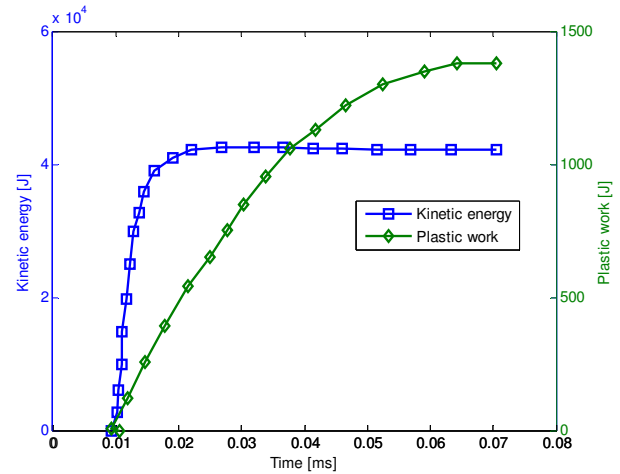

Figure 7: Energy distribution during time of the forming of explosively formed projectile, sample type 1, obtained by numerical method [3]

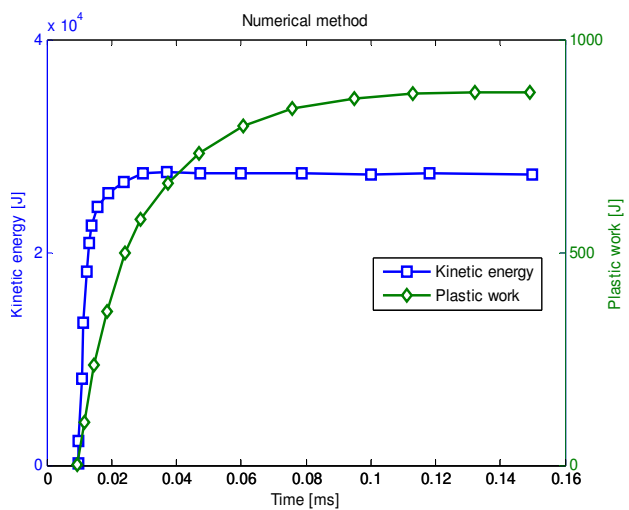

Figure 8: Energy distribution during time of the forming of explosively formed projectile, sample-type 2, obtained by numerical method [3]

These parameters are collected as the consequence of considering problems of deformation energy in the numerical and in the analytical models. Differences between two types of samples show that cover of the explosive sample influences as to increase of kinetic energy of projectile and also the increase of total plastic deformation work [1,2,10,13,20].

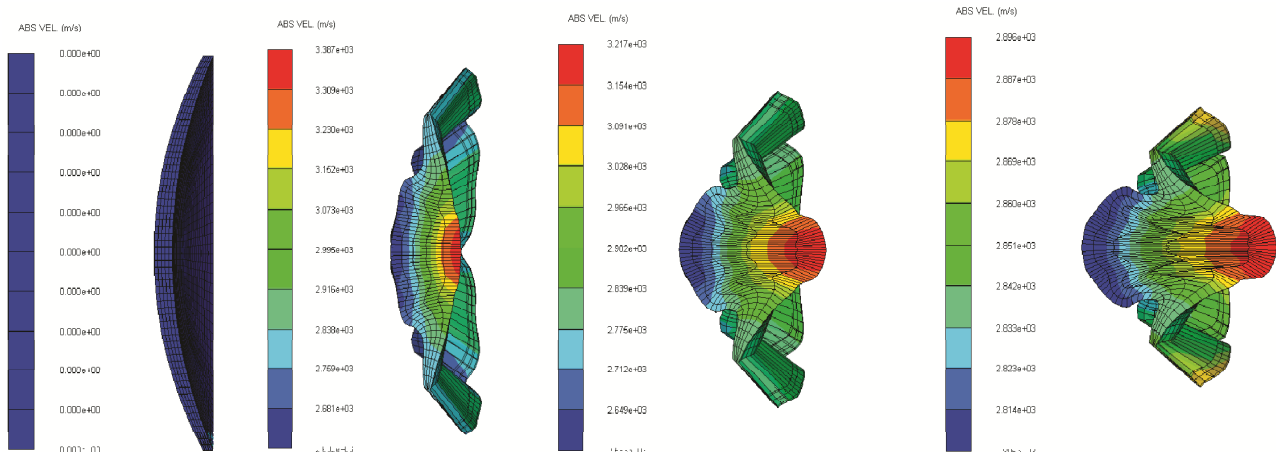

Figure 9: Shape of projectile configuration during forming to the final shape in 70 μ s of sample-type 1

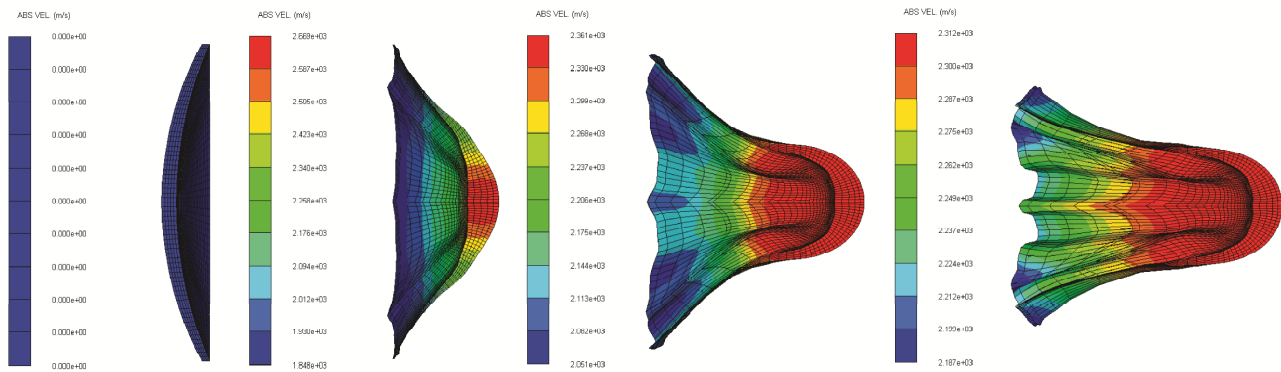

Figure 10: Shape of projectile configuration during forming to the final shape in 150 μ s of sample-type 2

Numerical simulation also reproduces expected shapes of projectiles at the end of forming process shown in (Figs. 9 and 10). For the sample *type 1* (Fig. 9) projectile is formed with its final shape after $t=70.5 \mu$ s at the distance 265.31mm, realizing final velocity of about 2860 m/s. For the sample *type 2* (Fig. 10) these values are corresponding to the instant $t=150 \mu$ s, at the distance 418.2 mm and velocity 2435 m/s. That means that sample *type 2* has much less coefficient of energy efficiency than covered warhead charges [10]. The final projectile shape joint with considered velocity performances influences two basic performances important for EFP warhead design – penetrability and precision.

5. CONCLUSION

The next conclusions are presented as the result of this study:

- The analytical and numerical approach is a well designed tool for the EFP velocity and energy modeling and estimations.
- Analytical model gave an approximately view on the process of forming and determination of EFP velocities gives results within approximated acceptable errors.
- Numerical method gives more accurate results regarding velocity in comparison with analytical method and these results are very close to experimental data, with error of less than 1.5%. It should be noted that numerical method is useful for the shortening the development time of EFP warheads during design and reduces the cost of their experimental testing.
- The same configuration of liners and explosive charges with and without metal covers produced different shapes of explosively formed projectiles. Sample *type 1* produced EFP as the plastic solid shape less adoptable for distance flight, and sample *type 2* produced EFP with more adoptable shape for distance flight regarding aerodynamical drag.

ACKNOWLEDGEMENTS

This research has been partially submitted as the paper on the OTEH conference 2014 and is further supported by the Ministry of Education, Science and

Technological Development of the Republic of Serbia, through the project III-47029, in the 2016 year, which is gratefully acknowledged.

REFERENCES

- [1] Орленко, Л.П. : *Физика Взрыва*, Главная редакция физико-математической литературы, Москва, 2004.
- [2] Sharma, VK, Kishore, P., Bhattacharyya, AR, Raychaudhuri, TK, Singh S.: *An Analytical Approach for Modeling EFP Formation and Estimation of Confinement on Velocity*, International Ballistics Society, pp.565-574.
- [3] Marković, M., Elek, P., Jaramaz, S. Milinović, M., Micković, D.. “Numerical and analytical approach to the modeling of explosively formed projectiles”, 6th International Scientific Conference OTEH 2014, October Belgrade, pp. 9-10, 2014.
- [4] Marković, M.: *Explosively Formed Projectiles*, MSc Thesis, University in Belgrade, Mechanical Engineering, Weapon Systems Department, 2011.
- [5] Markovic, M., Milinovic, M., Elek, P., Jaramaz, S., Mickovic, D. “Comparative approaches to the modeling of explosively formed projectiles”, Proceedings of Tomsk State University, Serie Physics and Mathematics, V.293, 2014.
- [6] Markovic M., Milinovic M., Jeremic O., Jaramaz S.. “Numerical modeling of temperature field on high velocity explosively formed projectile”, 17th Symposium On Thermal Science And Engineering Of Serbia, October 20–23, pp.175-181, 2015.
- [7] Pappu, S., Murr, L.E.: *Hydrocode and microstructural analysis of explosively formed penetrators*, Journal of Materials Science, pp. 233-248, 2002.
- [8] Hussain, G., et al.: *Gradient Valued Profiles and L/D Ratio of Al EFP With Modified Johnson Cook Model*, Journal of Materials Science and Engineering 5, pp. 599-604, 2011.
- [9] Fedorov, S.V., Bayanova Ya. M., Ladov, S.V. “Numerical analysis of the effect of the geometric parameters of a combined shaped-charge liner on the mass and velocity of explosively formed

- compact elements”, *Combustion, Explosion, and Shock Wave*, Vol. 51, No. 1, pp. 130-142, 2015.
- [10] Hussain, G., Hameed, A., Hetherington, J.G. “Analytical performance study of explosively formed projectile”, *Journal of applied mechanics and technical physics*, Vol.54, No.1, pp.10-20, 2013.
- [11] Bender, D., Corleone, J. “*Tactical Missile Warheads -Explosively Formed Projectile*”, American Institute of Aeronautic and Astronautic, Washington, 1993.
- [12] Teng, T.L., Chu, Y.A., Chang, f.a., Shen, B.C. “*Design and Implementation of a High Velocity Projectile Generator*”, *Fizika Goreniya I Vzryva*, Vol. 43, No. 2, pp. 233-240, 2007.
- [13] Weimann, K. “Research and development in the area of explosively formed projectiles charge technology”, *Propellants, Explosives, Pyrotechnics*, Vol. 18, pp. 294-298, 1993.
- [14] Jones, D.A., Kemister, G., Borg, R.A.J.: *Numerical Simulation of Detonation in Condensed Phase Explosives*, Weapons Systems Division Aeronautical and Maritime Research Laboratory, August 1998.
- [15] Lam, C., McQueen, D.: *Study of the Penetration of Water by an Explosively Formed Projectile*, Weapons Systems Division Aeronautical and Maritime Research Laboratory, June 1998.
- [16] Fong, R., Kraft, J., Thompson, L.M., Ng, W.: *3D Hydrocode Analysis of Novel Asymmetrical Warhead Designs*, Proceedings for the Army Science Conference (24th), 29 November - 2 December, Florida, pp.1-3, 2005.
- [17] Weibing, L., Xiaoming, W., Wenbin, L.: *The Effect of Annular multi-point Initiation on the Formation and Penetration of an Explosively Formed Penetrator*, *International Journal of Impact Engineering* 37, pp. 414-424, 2010.
- [18] Church, P.D., Cullis, I.: *Development and Application of High Strain Rate Constitutive Models in Hydrocodes*, *Journal de Physique IV*, Vol. 1, pp. 917-922, October 1991.
- [19] Luttwak, G., Cowler, M.S.: *Advanced Eulerian Techniques for the Numerical Simulation of Impact and Penetration using AUTODYN-3D*, International Symposium of Interaction of the Effects of Munitions with structures, Berlin, 3-7 May, 1999.
- [20] Jianfeng, L., Tao, H., Longhe, L., Bing, H.: *Numerical Simulation of Formation of EFP With Charge of Aluminized High Explosive*, International Symposium on Ballistics, Tarragona, Spain 16-20 April, 2007.

АНАЛИТИЧКА И НУМЕРИЧКА МЕТОДА ПОЉА БРЗИНЕ ЗА ЕКСПЛОЗИВНО ФОРМИРАНЕ ПРОЈЕКТИЛЕ

**О. Јеремић, М. Милиновић, М. Марковић,
Б. Раћуо**

Овај рад представља аналитички и нумерички приступ процену перформанси брзине за Експлозивно Формиране Пројектиле (ЕФП). Предложене аналитичке методе математички развијају параметре брзина појединачних сегмената за ЕФП диск погоњен експлозивним процесом. Овај модел базиран је на добро познатим теоријским приступима дистрибуције енергије на пластичним телима у динамичким условима формирањем интегралних решења за коначну брзину пројектила. Паралелно са аналитичким такође је развијен и нумерички метод у циљу обезбеђења процене понашање пројектила у току времена процеса формирања ЕФП-а погоњеног експлозивом. Оба модела су валидна за процену перформанси ЕФП бојевих глава и пројектних податка за оптимално пројективање облика ЕФП-а. Симулације су подржане софтверима Матлоб и Аутодин како за аналитичко тако и нумеричко моделирање. Добијени нумерички и аналитички резултати упоређени су са расположивим експерименталним резултатима.