

# Study of the Tractive Resistance of the No-till Planting Section

**S. Shepelev**

Doctor South Ural State Agrarian University  
Department of Operation of the machine  
and tractor fleet, and technology and  
mechanization of animal husbandry  
Russia

**M. Pyataev**

Ph.D. South Ural State Agrarian University  
Department of Operation of the machine  
and tractor fleet, and technology and  
mechanization of animal husbandry  
Russia

**E. Kravchenko**

Postgraduate student South Ural State  
Agrarian University Department of  
Operation of the machine and tractor fleet,  
and technology and mechanization of  
animal husbandry  
Russia

*The paper presents the results of studying the tractive resistance of the combined sowing section for no-till technology-based seeding. The sowing section consists of a slotting disk, an anchor colter, and a press wheel. To ensure the stability of the colter motion, the section has a parallelogram suspension and a balancing wheel with an adjustable vertical force acting on it, depending on the soil resistivity and the tilling depth. The sowing section ensures that the seeds are sown at a given depth in a moistened soil layer according to the agrotechnical requirements. Based on the theoretical studies, an analytical dependence was obtained, which allows for determining the tractive resistance of individual tools and the sowing section, depending on the design and operating parameters. The paper presents the results of the experimental studies on the dynamometer testing of the sowing section in laboratory conditions. To this end, an analog-digital measuring and computing complex and a software suite were used for the experimental data's post-experimental processing. Experimental dependences of the tractive resistance of individual tools and the sowing section, in general, were obtained, confirming the theoretical studies' correctness. The nominal tractive force of tractors was approximately determined, and the results of laboratory-field and field experiments with the sowing complex were presented.*

**Keywords:** sowing section, no-till, colter, tractive resistance, sowing complex

## 1. INTRODUCTION

Tools are important elements of seeding machines used in the no-till technology [1-5]. These are generally combined sowing sections simultaneously performing several heterogeneous operations: cutting the upper compacted soil layer, furrowing, laying the seed into the soil, and seeding down [4, 5]. Taking into account the substantial variety of physical and mechanical properties of soil, the condition of the agricultural background, and the planned seeding depth necessary for the above operations, various sowing sections significantly differ from each other in design [6-10].

The purpose of the research is to study the usability of a combined sowing section for the no-till technology-based seeding in acute moisture deficiency conditions and to assess its operation's main energy indicators. A distinctive feature of the research is that the developed section should seed at a strictly defined soil moisture depth. During dry periods, moisture can be found at considerable depths [11-13]. To this end, rather tough requirements to ensure the seeding depth in the range from 5 to 15 cm and its uniformity are imposed on the operation of the section [14-19].

A review of the designs of sowing sections [1, 2, 4, 5], as well as the previous studies, allowed establishing that it is most expedient to use a combined sowing

section with a slotting disk, an anchor colter, and a press wheel for the no-till technology-based seeding (Fig. 1). The section provides furrowing to the depth of the soil moisture.

The review of the configurations of sowing sections has shown that the available samples cannot fully ensure the fulfillment of agrotechnical requirements, especially if it is necessary to sow at a depth of 15 cm. So the section described in [1] can operate in heavy soils with a significant amount of plant residues; however, sowing is carried out at a depth of no more than 10 cm. The sowing section described in [2] has a high degree of unification, as it can be used with various colters; however, the construction scheme does not provide satisfactory seed rolling. The tool considered in [5] is adapted to operate at considerable depths; however, it is not fitted with a rolling device and a cutting disk, which causes the formation of a significant furrow during sowing resulting in moisture loss. Thus, it is proposed to use a combined sowing section for no-till sowing, which is fitted with a slotted disk, an anchor colter, and a press wheel (Fig. 1). The section provides for the formation of a furrow to the soil moisture depth.

The stability of the depth of seeding down with an anchor colter in moistened soil layers located at a depth of up to 15 cm is ensured by the use of a parallelogram suspension and a balancing wheel, which jointly provide high-quality following of the soil surface microrelief. At the same time, high stability of the colter motion is achieved by adjusting the vertically directed force exerted on the balancing wheel from the parallelogram suspension spring. This force is selected depending on the soil hardness and the tilling depth.

Received: March 2022, Accepted: July 2022

Correspondence to: Dr Sergey Shepelev  
South Ural State Agrarian University, 75 Lenin Avenue,  
Chelyabinsk 454080, Russia

E-mail: shepelev2@ya.ru

doi:10.5937/fme2203502S

© Faculty of Mechanical Engineering, Belgrade. All rights reserved

FME Transactions (2022) 50, 502-511 502

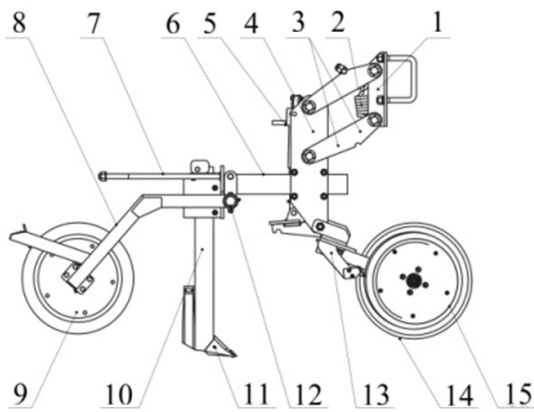

**Figure 1.** The sowing section (1 - parallelogram suspension mechanism; 2 - spring; 3 - top and bottom links of the parallelogram suspension; 4 - section body; 5 - depth adjuster; 6 - plough beam; 7 - spring of the press wheel; 8 - press wheel bracket; 9 - press wheel; 10 - colter rack; 11 - colter; 12 - hinge to fasten the press wheel bracket; 13 - balancing wheel bracket; 14 - slotting disk; 15 - balancing wheel)

Considering the expected operating conditions of the sowing section (matted stubble ground, high soil hardness, major seeding depth), assessing its tractive resistance is of particular importance. The energy performance of the sowing section is essential for determining the expected drawbar category and further evaluating the performance of the sowing machine-tractor aggregate, fuel consumption, and choosing the efficiency of the seeding process in general [20–23]. It is known that the most energy is consumed during the sowing machine operation to overcome the tools' tractive resistance [24–25]. To this end, it is relevant to carry out theoretical and experimental studies on assessing the tractive resistance of the sowing section for the direct seeding technology.

## 2. THEORETICAL STUDIES OF THE TRACTIVE RESISTANCE OF THE SOWING SECTION

When the tools of the sowing section (slotting disk, balancing wheel, anchor colter, press wheel) interact with the soil, there arise forces, which can be represented as vertical and horizontal components (Fig. 2). The horizontal components of the forces acting on the tools of the sowing section determine the value of its tractive resistance [26–29]. Thus, the resistance of the entire sowing section can be represented as the following sum:

$$R = P_1 + P_2 + P_3 + P_4 \quad (1)$$

where  $P_1$  is the tractive resistance of the slotting disk, kN;  $P_2$  is the tractive resistance of the balancing wheel, kN;  $P_3$  is the tractive resistance of the press wheel, kN;  $P_4$  is the tractive resistance of the anchor colter, kN.

The vertical components of the forces acting on the balancing wheel ( $P_5$ ), the slotting disk ( $P_6$ ), the anchor colter ( $P_7$ ), and the press wheel ( $P_8$ ) do not directly affect the tractive resistance of the section. Still, they correlate with it to a certain extent. It was evident that with an increase in the vertical force exerted on the balancing wheel, the growing reaction of  $P_5$  will cause an increase in the tractive resistance  $P_1$  and the entire

sowing section. Similar to the case with the press wheel, an increase in  $P_5$  leads to an increase in  $P_3$ .

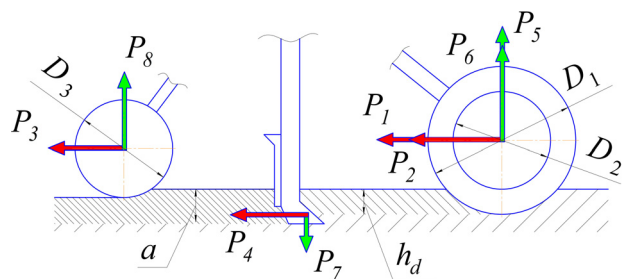

**Figure 2.** Components of the tractive resistance of the sowing section

The value of tractive resistance  $R$  is determined by the physical and mechanical properties of the soil, as well as the design and operating parameters of the tools. The nature of the change in the forces making up the tractive resistance of the section, depending on the main design and operating parameters, will be further considered theoretically.

The main task of the slotting disk of the sowing section is to prepare the soil for the anchor colter to pass along its track so that crop residues are not involved in furrowing. The disk also reduces the tractive resistance of the sowing section to some extent and the effect of soil removal to the surface when the anchor colter passes.

Satisfactory operation of the slotting disk is ensured only at a certain value of its diameter  $D_1$  when the soil and the layer of crop residues on its surface are stably cut. Based on this condition, the preliminary value of the diameter can be determined from the following ratio:

$$D_1 \geq \frac{2h_d}{(1 - \cos(\varphi_1 + \varphi_2))} \quad (1)$$

where  $h_d$  is the depth of the disk motion in the soil, m;  $\varphi_1, \varphi_2$  is the angle of friction of the soil and crop residues on the disk blade, respectively, degrees ( $\varphi_3 + \varphi_4 = 40 \dots 58^\circ$ );

When the slotting disk moves in the soil, its tractive resistance is caused by the force  $T$  resulting from the friction of its side planes on the soil and the force  $R_d$  resulting from the soil reactance:

$$P_1 = T + R_d \quad (2)$$

The value of the  $T$  component taken in conjunction with the design parameters of the disk can be determined from dependence (3):

$$T = \frac{p \cdot f \cdot D_1^2}{4} \cdot \left[ \frac{\pi}{180} \cdot \arccos \left( 1 - \frac{2h_d}{D_1} \right) - \sqrt{1 - \left( 1 - \frac{2h_d}{D_1} \right)^2} \right] \quad (3)$$

where  $f$  is the coefficient of the soil friction on steel;  $p$  is the soil pressure on the side surface of the disk, kN/m<sup>2</sup>;  $D_1$  is the diameter of the slotting disk, m.

Taking into account the design parameters of the slotting disk, the value of the  $R_d$  component can be determined from dependence (4):

$$R_d = \sigma D_1 \left( 1 - \cos \left( \frac{1}{2} \arccos \left( 1 - \frac{2h_d}{D_1} \right) \right) \right) \quad (4)$$

where  $\sigma$  is the coefficient of soil resistivity when interacting with the slotting disk, kN/m.

Based on dependencies (3) and (4), the following graph can be constructed (Fig. 3).

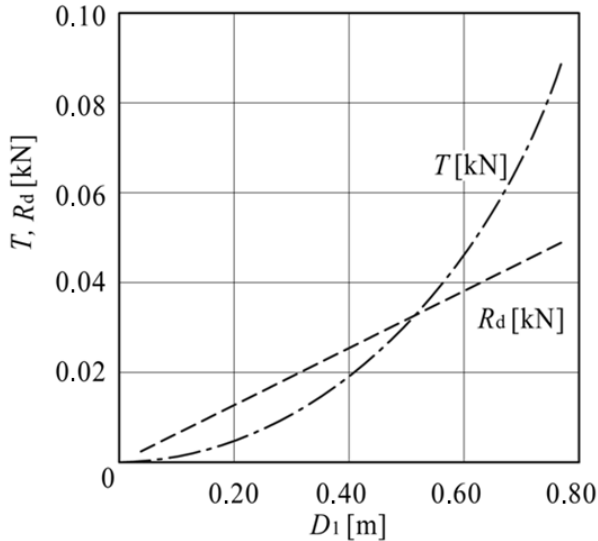

**Figure 3. The dependence of the components of the tractive resistance of the slotting disk on the diameter**

It has been established that with an increase in the diameter  $D_1$  of the disk, the resistance increases, especially due to an increase in the component  $R_d$ . The change in the force  $T$  is non-linear. Notably, in case the value of the motion depth is constant  $h_d=0.04$ m, with an increase in the diameter  $D_1$ , the force  $T$  changes more intensively with respect to  $R_d$  due to an increase in the area of the side surface of the disk interacting with the soil. In this regard, it is most efficient to take the disk diameter equal to  $D_1=470$  mm since this provides an acceptable value of the tractive resistance and meeting conditions (1).

The tractive resistance of the balancing wheel and the press wheel can be determined from similar dependencies (5) and (6), respectively, as they similarly interact with the soil:

$$P_2 = 2b_2q \left( \frac{D_2 - 2h_2}{2} \right)^2 \operatorname{tg}^4 \left( \frac{1}{2} \arccos \left( 1 - \frac{2h_2}{D_2} \right) \right) \quad (5)$$

$$P_3 = 2b_3q \left( \frac{D_3 - 2h_3}{2} \right)^2 \operatorname{tg}^4 \left( \frac{1}{2} \arccos \left( 1 - \frac{2h_3}{D_3} \right) \right) \quad (6)$$

where  $b_2, b_3$  is the width of the rim of the balancing wheel and the press wheel, respectively, m;  $q$  is the coefficient of the volume soil deformation, kN/m<sup>3</sup>;  $h_2, h_3$  is the track depth after the passage of the balancing wheel and the press wheel, respectively, m;  $D_2, D_3$  is the diameter of the balancing wheel and the press wheel, respectively, m.

The width of the rim is selected based on the value of the allowable pressure on the soil and is  $b_2=0.12$  m

for the balancing wheel and  $b_3=0.025$  m for the press wheel. At the same time, based on the calculations, it has been established that an increase in the diameters of the balancing wheel and the press wheel  $D_2$  and  $D_3$ , respectively, has little effect on the change in the tractive resistance  $P_2$  and  $P_3$  in the considered range of the values from 0.20 to 0.6m (Fig. 4). Notably, the determining influence on the tractive resistance of these tools is exerted by the values of the vertical forces acting on them and generating reactions  $P_5$  and  $P_8$ . The values of these reactions are determined by the weight of the structure and the adjusting springs of the section (pos. 2 and pos. 7 in Fig. 1). Thus, to determine the diameters, the requirements for ensuring the agrotechnical passing ability of the section should be used, according to which the minimum allowable diameter of the balancing and press wheels can be determined by dependence (7):

$$D_{2,3 \min} \geq D_c \cdot \operatorname{ctg}^2 \left( \frac{\varphi_3 + \varphi_4}{2} \right) \quad (7)$$

where  $D_c$  is the diameter of the soil clod (0.10...0.12 m);  $\varphi_3, \varphi_4$  is the angle of friction of the soil clod on the soil and the rim material, degrees ( $\varphi_3+\varphi_4=55...65^\circ$ ).

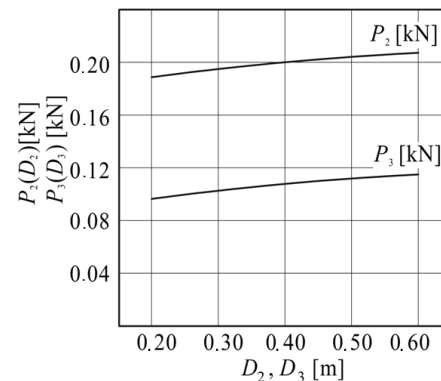

**Figure 4. The dependence of the tractive resistance of the balancing and press wheels on their diameters**

Taking into account the calculated values of the tractive resistance and the calculations of the minimum allowable diameters using the ratio (7), the values of the diameters  $D_2$  and  $D_3$  should be selected from the range of 0.30...0.40 m.

The most sizeable term in sum (1) is the tractive resistance of the anchor colter. Taking into account potential seeding to a depth of 15 cm, the tractive resistance of the colter can be represented as the sum of the horizontal component of the resistance force acting on the chisel and the rack:

$$R_4 = R_{\text{col}} + R_r, \quad (8)$$

The interaction of the anchor colter chisel with the soil is similar to that of a two-sided wedge; therefore, its tractive resistance can be calculated from dependence (9):

$$R_{\text{col}} = a \cdot b_{\text{col}} \cdot \gamma_0 \operatorname{tg}(\beta_0 + \varphi_0) \left( v^2 \cdot \sin(\beta_0) + \frac{g \cdot h_r}{\sin(\beta_0)} \right) 10^{-1} \quad (9)$$

where  $a$  is the tilling depth, m;  $b_{\text{col}}$  is the chisel width, m;  $\gamma_0$  is the volume soil weight, kg/m<sup>3</sup>;  $v$  is the wedge speed, m/s;  $\beta_0$  is the angle of setting the chisel to the

furrow bottom, degrees;  $\varphi_0$  is the angle of soil friction on the working surface of the chisel, degrees;  $h_f$  is the furrow slice uplift height, m;  $g$  is the free-fall acceleration,  $m/s^2$ .

The force acting from the soil on the rack can be determined by dependence (10):

$$R_r = k_1 a_r (b_r + 2d_r \cdot f) \quad (10)$$

where  $a_r$  is the motion depth of the colter rack, m;  $k_1$  is the resistivity coefficient of the soil with the unchanged structure,  $kN/m^2$ ;  $b_r$  is the thickness of the colter rack, m;  $d_r$  is the width of the colter rack, m.

During the technological process, the rack moves directly along the track of the slotting disk, which vertically cuts the soil to a constant depth  $h_d$  loosening the soil and thus reducing its resistivity from  $k_1$  to  $k_2$ . Thus, dependence (10) can be represented in its final form as follows:

$$R_r = (k_1(a_r - h_d) + k_2 \cdot h_d)(b_r + 2d_r \cdot f). \quad (11)$$

where  $k_2$  is the resistivity coefficient of the soil with the changed structure,  $kN/m^2$ .

Taking into account (9) and (11), dependence (8) can be written as follows:

$$P_4 = a \cdot b_{col} \cdot \gamma_0 \cdot g (\beta_0 + \varphi_0) \left( v^2 \cdot \sin(\beta_0) + \frac{g \cdot h_f}{\sin(\beta_0)} \right) 10^{-1} + (k_1(a_r - h_d) + k_2 \cdot h_d)(b_r + 2d_r \cdot f) \quad (12)$$

With an increase in the depth  $a$ , the tractive resistance  $R_4$  increases (Fig. 5). Depending on the soil resistivity, the use of the slotting disk can reduce the tractive resistance of the anchor colter by about 10...15% since a part of the rack passes through the soil structure changed from interaction with the slotting disk.

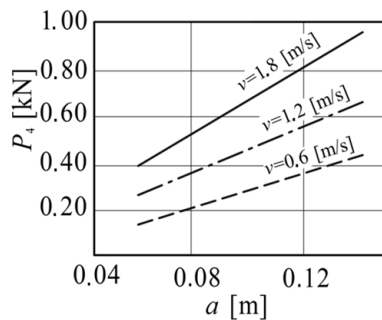

Figure 5. The dependence of the tractive resistance of the anchor colter on the tilling depth and the motion speed

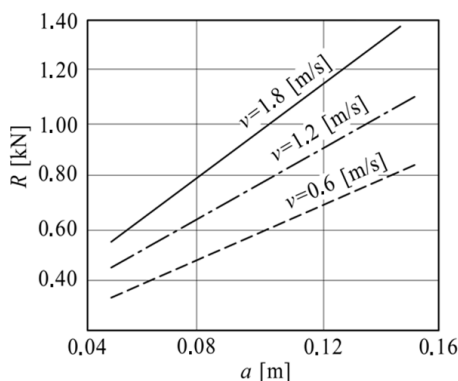

Figure 6. The dependence of the tractive resistance of the sowing section on the tilling depth and the motion speed

In the final form, the dependence for calculating the tractive resistance of the sowing section can be represented as follows:

$$R = \frac{p \cdot f \cdot D_1^2}{4} \left( \frac{\pi}{180} \cdot \arccos \left( 1 - \frac{2h_d}{D_1} \right) - \sqrt{1 - \left( 1 - \frac{2h_d}{D_1} \right)^2} \right) + \sigma D_1 \left( 1 - \cos \left( \frac{1}{2} \arccos \left( 1 - \frac{2h_d}{D_1} \right) \right) \right) + b_2 q \left( \frac{D_2 - 2h_2}{2} \right)^2 \cdot g^4 \left( \frac{1}{2} \arccos \left( 1 - \frac{2h_2}{D_2} \right) \right) + 2b_3 q \left( \frac{D_3 - 2h_3}{2} \right)^2 \cdot g^4 \left( \frac{1}{2} \arccos \left( 1 - \frac{2h_3}{D_3} \right) \right) + a \cdot b_{col} \cdot \gamma_0 (\beta_0 + \phi_0) \cdot \left( v^2 \cdot \sin(\beta_0) + \frac{g \cdot h_f}{\sin(\beta_0)} \right) 10^{-1} + (k_1(a_r - h_d) + k_2 \cdot h_d)(b_r + 2d_r \cdot f) \quad (13)$$

The nature of the change in the tractive resistance of the sowing section depending on the tilling depth can be represented graphically in the following form (Fig. 6).

The change in the tractive resistance  $R$  of the sowing section (Fig. 6) depending on the depth  $a$  and the speed  $v$  is similar to the above change in the resistance  $P_4$  of the anchor colter (Fig. 5), taking into account the increase in the values by the additional resistance of the section's tools (slotting disk  $P_1$ , balancing and press wheels  $P_2, P_3$ ). With an increase in the tilling depth, the tractive resistance of the sowing section is increased linearly. The tractive resistance also increases with an increase in soil resistivity.

### 3. EXPERIMENTAL STUDIES OF THE TRACTIVE RESISTANCE OF THE SOWING SECTION IN LABORATORY CONDITIONS

The experimental studies of the tractive resistance of the sowing section were carried out in laboratory conditions. To this end, an experimental model of the sowing section was placed on a driven trolley using a special fastening (Fig. 7)

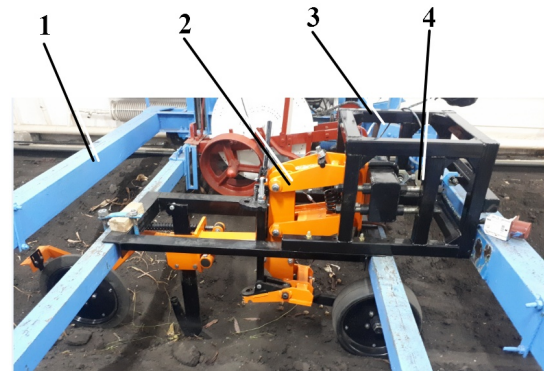

Figure 7. The sowing section on a driven trolley in the laboratory (1 – driven trolley of the tillage bin; 2 – sowing section; 3 – fastening; 4 – strain gauge)

To confirm the results of the theoretical studies, the following factors were chosen as controllable in the experiment:

- The speed of the sowing section,  $v$ , m/s. During the experiment, it was changed in the range from 0.6 to 1.8 m/s using the power-drive station of the tillage bin;



- The colter motion depth,  $a$ , m. During the experiment, it was changed in the range from 0.06 to 0.12 m using the lifting frame of the driven trolley;
- The value of the reaction acting on the balancing wheel,  $P_5$ , kN. It was regulated in the range from 1.0 to 2.0 kN by changing the spring force of the parallelogram mechanism and the sowing section depth adjuster. The value of the set force  $P_5$  was controlled by the scales (Fig. 8).

The main design parameters affecting the resistance of the sowing section were taken constant based on the results of the above theoretical calculations.

The experiment was conducted according to one-factor plans by a sequential search of all controllable factors.



**Figure 8. Static determination of the reaction acting on the balancing wheel using the VA-15 scales (a - remote control panel of the scales; b - scales platform)**

Experiments were also carried out to assess the tractive resistance of individual tools of the sowing section. The tractive resistance of the anchor colter of the sowing section without the press wheel, the slotting disk, and the balancing wheel was determined. In this experiment, only the anchor colter was installed on the section; other tools were dismantled (Fig. 9)



**Figure 9. Determining the tractive resistance of the anchor colter of the sowing section**

The tractive resistance of the balancing wheel without the slotting disk (Fig. 10a) and with the slotting disk (Fig. 10b) was determined separately. In this experiment, the anchor colter and the press wheel were dismantled.

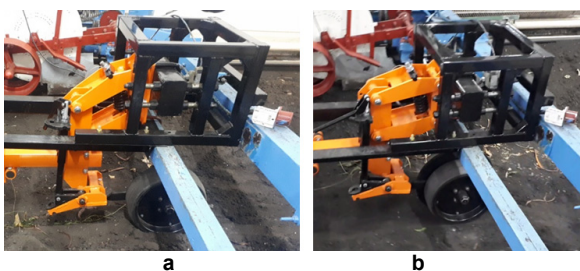

**Figure 10. Determining the tractive resistance of the balancing wheel without the slotting disk (a), with the slotting disk (b)**

The tractive resistance of the sowing section and its tools was measured separately using the MIC-400D measuring and computing complex and a strain gauge with a nominal tensile force of 0.5 tons (Fig. 11).

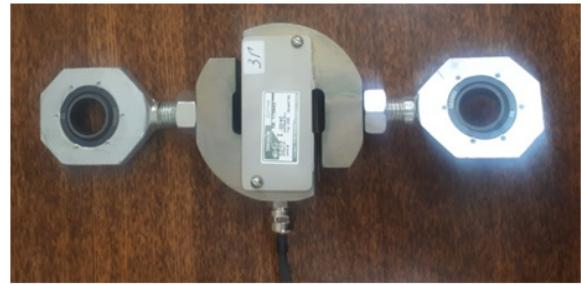

**Figure 11. Strain gauge**

The measurement data obtained during the experiment were processed using the Recorder 3.4.0.16 program installed on the MIC-400D complex. The subsequent analysis and data processing were carried out using the WinPOS 3.2.8.31 suite for post-experimental measurement information processing.

Prior to the experiments, the main physical and mechanical properties of the soil in the tillage bin: hardness, moisture content, and density, were determined (Table 1).

**Table 1. Physical and mechanical properties of the soil**

INDICATOR	Value
Soil moisture, %, in the layer, cm	
0...5	1.9
5...10	3.0
10...15	5.2
15...20	7.4
Soil hardness, MPa, in the layer, cm	
0...5	0.59
5...10	0.94
10...15	1.22
15...20	1.74

The results of determining the tractive resistance  $P_4$  of the anchor colter experimentally, depending on the travel speed  $v$  and the tilling depth  $a$ , are graphically shown in Fig. 12.

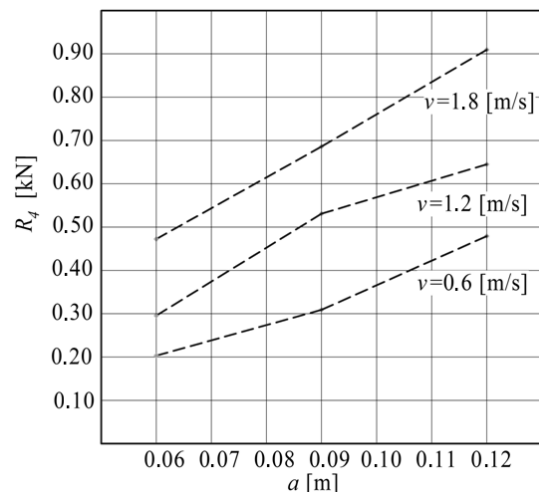

**Figure 12. The dependence of the tractive resistance  $P_4$  of the anchor colter on the working speed and the tilling depth**

With an increase in the working speed  $v$  and the tilling depth  $a$ , the tractive resistance  $P_4$  naturally increases, which is consistent with the results of the theoretical studies. Thus, the determining factors of the tractive resistance of the anchor colter are the tilling depth, the motion speed, and the physical and mechanical properties of the soil. The second sizeable term in the tractive resistance of the sowing section (1) is the resistance  $P_2$  of the balancing wheel. Based on the obtained experimental data, the following dependence of the tractive resistance of the wheel  $P_2$  on the vertical reaction  $P_5$  acting on it was constructed (Fig. 13).

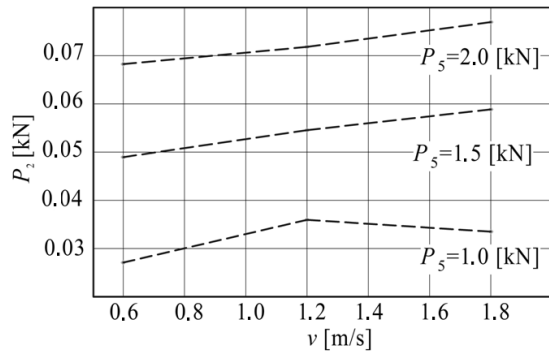

**Figure 13.** The dependence of the change in the tractive resistance  $P_2$  of the balancing wheel on the working speed and the value of the vertical reaction  $P_5$

The value of the vertical reaction  $P_5$  should be selected depending on the tilling depth  $a$  and the soil resistivity to ensure a stable motion of the sowing section and an appropriate uniformity of the seeding depth. As we can see from the resulting graph (Fig. 13), the value of the vertical reaction  $P_5$  acting on the balancing wheel significantly affects  $P_2$ . Thus, based on the data obtained experimentally, the value of the tractive resistance of the balancing wheel will be about 5...10% of the colter resistance, depending on the depth  $a$ . Notably, the speed in the considered range generally affects the force  $P_2$ , and this effect is most significant at higher values of the vertical force acting on the balancing wheel.

The installation of the slotting disk slightly increases the tractive resistance. Based on the obtained experimental data, the following graphical dependences of the change in the tractive resistance  $P_1+P_2$  of the slotting disk interlocked with the balancing wheel will be constructed (Fig. 14).

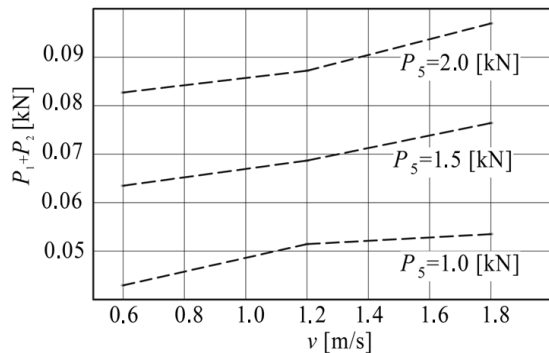

**Figure 14.** The dependence of the change in the tractive resistance  $P_1+P_2$  of the slotting disk with the balancing wheel depends on the working speed and the value of the vertical reaction  $P_5$

After analyzing the form of the obtained dependences (Fig. 14), it can be concluded that using an additional element (slotting disk) has expectedly increased the tractive resistance. However, in general, the nature of the obtained dependences versus the previously presented ones (Fig. 13) has not changed significantly. Notably, an increase in tractive resistance due to the addition of the slotting disk will be leveled by a decrease in tractive resistance of the anchor colter following its trail.

Especially when the slotting disk is used, the effect of soil removal by the anchor colter following its trail is significantly reduced. It is obvious when the furrows left by the sowing section after passing with and without the installed slotting disk are visually inspected (Fig. 15).



**Figure 15.** A furrow left after the passage of the sowing section: a - the sowing section with the installed slotting disk; b - the sowing section without the installed slotting disk

Figure 16 shows the change in the value of the tractive resistance of the sowing section without and with the installed slotting disk, depending on the tilling depth  $a$  and the speed  $v$ .

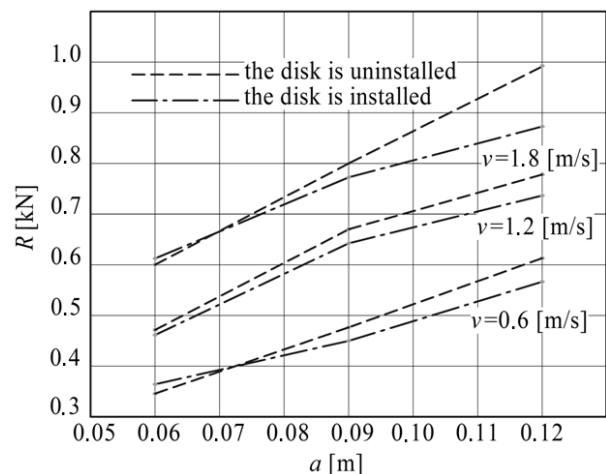
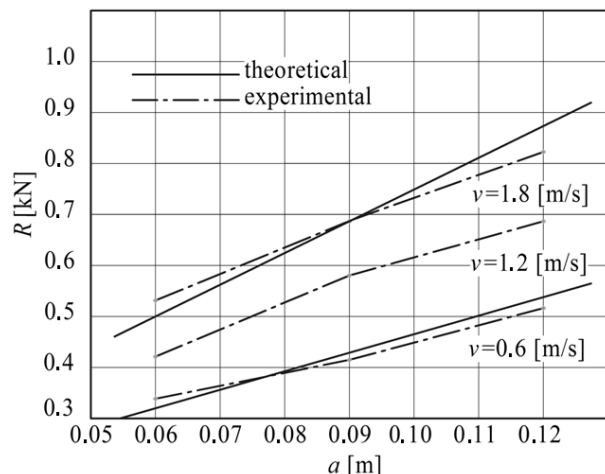

**Figure 16.** The dependence of the tractive resistance of the sowing section (with and without the installed slotting disk) on the working speed and tilling depth (with a vertical load  $P_5=2.0\text{kN}$ )

The nature of the change in the tractive resistance of the sowing section without and with the installed slotting disk is generally similar; it grows with an

increase in the speed  $v$  and the tilling depth  $a$ . At the same time, analyzing the results of the experiments, it can be noted that the tractive resistance of the sowing section with the installed slotting disk is lower than that without the disk. On average, the tractive resistance of the sowing section with the installed slotting disk is 0.04kN lower than that without the disk. Considering the relatively low value of soil resistivity in the laboratory conditions of the tillage bin, it can be expected that the above difference will be much higher in the field conditions.

The degree of conformity of the results of the theoretical and experimental studies based on the following graph will be further considered (Fig. 17).



**Figure 17. The regularity of the change in the tractive resistance of the sowing section (with the slotting disk)  $R$  depends on the working speed and the tilling depth of the colter at  $P_5=1.0\text{kN}$**

A similar graph will be constructed to assess the balance wheel's influence on the tractive resistance of the section at different values of the vertical reaction  $P_5$ , increasing the value from 1.0kN to 2.0kN will be constructed (Fig. 18).

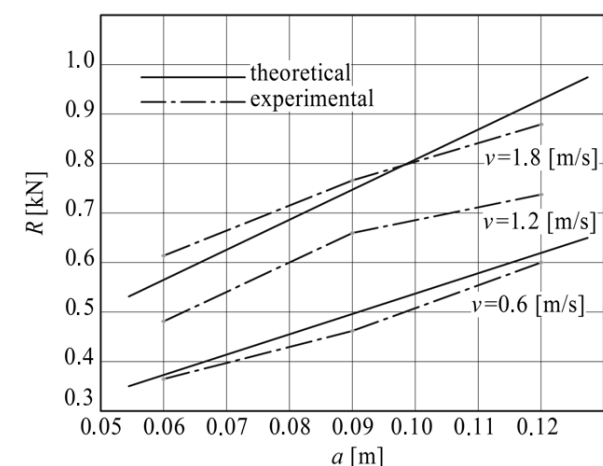

**Figure 18. The dependence of the tractive resistance of the sowing section (with the slotting disk)  $R$  on the working speed and the tilling depth of the colter at  $P_5=2.0\text{kN}$**

Based on the type of the obtained graphs (Fig. 17 and Fig. 18), it can be concluded that the value of the tractive resistance of the sowing section obtained experimentally increases with an increase in the depth  $a$ ,

the speed  $v$ , and the value of the reaction  $P_5$ , similarly to the data obtained from the theoretical studies.

Based on the theoretically and experimentally obtained values of the tractive resistance of the sowing section, the paper can recommend tractors of the following categories as a first approximation. It is supposed to install 37 sowing sections on a sowing complex with a working width of 10m and a planting width of 0.27m, based on which a tractor with a rated tractive force of 50kN should be equipped with such a seeder. At a working width of 12m, 48 sowing sections should be installed on the seeder, so a tractor with a rated tractive force of 80kN should be used.

#### 4. LABORATORY AND FIELD EXPERIMENTS

To confirm the objectivity of the results of the theoretical studies and laboratory experiments, laboratory-field and field experimental studies were carried out with the PK-12.7 sowing complex equipped with combined sowing sections (Fig. 19).



**Figure 19. PK-12.7 sowing complex equipped with combined sowing sections**

The specifications of the PK-12.7 sowing complex are presented in Table 2.

**Table 2. Specifications of the PK-12.7 sowing complex**

Name of parameter	Value
Type	tractor-drawn, tiller
Drawbar category	8
Working speeds, km/h	7...10
Operating width, m	12.7
Transport speed, km/h	20
Productivity per 1 hour, ha	7.0
Overall dimensions of the machine, mm in the operating position:	
- length	25,615
- width	13,375
- height	5,535
Operating mass of the machine, kg	21,200
Tanker capacity, $\text{dm}^3$	6.9

The experiments were carried out in the Shchuchansky district of the Kurgan region, the Russian Federation. An analysis of the hydrothermal conditions of the area characterizes the moisture conditions of the growing season as arid and not completely favorable for the cultivation of agricultural crops.

The main agrotechnical and energy indicators of the PK-12.7 sowing complex operation were determined during the laboratory and field experiments.



It has been established that using combined sowing sections provides a good uniformity of the seeding depth. At the specified depth of 85 mm, the average depth based on the experiment's results is 86.1 at the variability index of 1.77%.

The tractive resistance of the sowing complex with the following physical and mechanical properties of the soil varies (Table 3) from 68.5 to 87.7kN at speeds from 1.38 to 2.21m/s. At the same time, the tractor propellers slip in the permissible range from 7.0 to 11.8%.

**Table 3. Physical and mechanical properties of the soil**

Indicator	Value
Soil moisture, %, in the layer, cm	
0-5	15.6-19.5
5-10	16.5-19.6
10-15	16.0-16.2
Soil hardness, MPa, in the layer, cm	
0-5	1.69
5-10	1.71
10-15	1.83

During the field experiments, the characteristics of plants by sprouts and before harvesting and estimated yield were determined (Table 4).

**Table 4. Results of the field experiment**

INDICATOR	Value
Seeding rate, kg/ha	130
Crop	wheat
Variety	Omskaya-36
Characteristics of sprouts	
Quantity of sprouts, pcs/m <sup>2</sup>	284
Field germination rate, %	84.5
Quantity of stems, pcs/m <sup>2</sup>	578
Tillering coefficient	2.6
Biomass of sprouts, g/m <sup>2</sup>	482
Soil hardness, MPa, in the layer, cm	
Quantity of productive stems, pcs/m <sup>2</sup>	305
Quantity of grains in the head, pcs.	30.7
Mass of 1,000 grains, g	28.3
Yield at the planting rate, centners/ha	26.5

The obtained yield of 26.5 centners/ha can be considered satisfactory for arid conditions. This effect is achieved mainly due to the use of combined sowing sections, which do provide not only good uniformity of seeding down but also form protective ridges on the soil (Fig. 20), allowing one to retain and accumulate moisture, as well as to protect sprouts from the negative impact of wind at early vegetation stages.



**Figure 20. Sprouts of grain crops after sowing with the PK-12.7 complex**

## 5. CONCLUSION

A mathematical model was obtained to determine the tractive resistance of the combined sowing section, depending on the design and operating parameters. It was established theoretically that the tractive resistance, depending on the operating conditions, can increase from 0.4kN to 1.2kN with an increase in the tilling depth from 0.05m to 0.15m. Design documentation and an experimental sample of the sowing section were developed based on these studies. The experimental studies of the sowing section sample in the soil channel confirmed the results of the theoretical studies.

Design documentation was prepared, and a sowing complex for no-till sowing was manufactured. The generalization of the results of the sowing section's theoretical and experimental studies allowed determining the sowing complex's main operational and technical specifications for the no-till technology. Thus, the drawbar categories of tractors were established to be configured with sowing complexes with an operating width of 10 and 12m.

The laboratory and field experiments with the developed sowing complex showed the possibility of uniform seeding to 8 cm or more depth. Using the developed sowing complex in the grain farming technology allows one to achieve a high yield of grain crops of 26.7c/ha given a significant moisture deficit.

At the same time, it was established that the developed sowing complex has an increased resistance, reaching 87.7kN in some modes, which forms the basis for further research to reduce resistance.

## REFERENCES

- [1] Sysuev, V.A., Kurbanov, R.F., Demshin, S.L., Saitov, V.E., Doronin, M.S.: Parameters and operating modes of the coulter group of the sod seeder, in: *IOP Conference Series: Earth and Environmental Science*, Vol. 723 (2), Article Number 022050, 2021, doi:10.30766/2072-9081.2020.21.3.321-331
- [2] Rakhimov, R.S., Rakhimov, I.R., Fetisov, E.O., Khamitov, Ya.Yu., Dymshakov, F.I.: Multi-purpose sowing machine for agricultural crops using various technologies, in: *IOP Conference Series: Earth and Environmental Science*, Vol. 699 (1), Article Number 012013, 2021, doi:10.1088/1755-1315/699/1/012013
- [3] Ognev I.I., Zyryanov A.P., Pyataev M.V., Gulyarenko A.A.: The influence of the parameters of a pneumatic grain seeder distributor on the uniform distribution of seeds, in: *E3S Web of Conferences International Conference on Modern Trends in Manufacturing Technologies and Equipment (ICMTMTE 2020)*, Vol. 193, Article Number 01031, 2020, doi: https://doi.org/10.1051/e3sconf/202019301031
- [4] Dridiger, V.K., Gadzhumarov, R.G.: Soil density, soil moisture content and maize yield using No-till technology of cultivation, in: *IOP Conference Series: Earth and Environmental Science*, Vol. 843



- (1), Article Number 012023, 2021. doi:10.1088/1755-1315/843/1/012023
- [5] Younis, A.F., Tahir, H.Th., Kareem, T.H.: A cleaning device to improve the seeding performance of a zero-tillage seeder, *International Journal of Agricultural and Statistical Sciences*, Vol. 16, pp. 1209-1215, 2020.
- [6] Chekusov, M., Schmidt, A., Kem, A.: Agrotechnical Assessment of the Work of the Furrow Opener During the Cultivation of Cereals Using Intensive Technology, in: *Fundamental and Applied Scientific Research in the Development of Agriculture in the Far East. Agricultural Innovation Systems, Vol.1*, pp. 164-173, 2022, DOI: 10.1007/978-3-030-91402-8\_20
- [7] Nukeshev, S.O., Kakabaev, N.A., Romanyuk, N.N., Troyanovskaya, I.P., Smelik, V.A., Voinash, S.A.: Design and rationale for parameters of the seed-fertilizer seeder coulter for subsoil broadcast seeding, in: *IOP Conference Series: Earth and Environmental Science*, Vol. 677 (5), Article Number 052010, 2021, doi:10.1088/1755-1315/677/5/052010
- [8] Belyaev, V.I., Vol'Nov, V.V., Iakovlev, D.A., Sokolova, L.V.: The influence of the sowing coulters type on the seeding quality and the spring wheat yield, in: *IOP Conference Series: Materials Science and Engineering*, Vol. 941 (1), Article Number 012042, 2020, doi:10.1088/1757-899X/941/1/012042
- [9] Alekseev, E.P., Maksimov, I.I., Terentev, A.G., Maksimov, E.A.: Seed distribution by the coulter for the subsoil broadcast seeding, in: *Journal of Physics: Conference Series*, Vol. 1515 (4), Article Number 042040, 2020, doi:10.1088/1742-6596/1515/4/042040
- [10] Zaitsev, A.M., Solodun, V.I., Gorbunova, M.S.: Comparative evaluation of seeding spring wheat methods when using different types of coulters, in: *IOP Conference Series: Earth and Environmental Science*, Vol. 421 (6), Article Number 062017, 2020, doi:10.1088/1755-1315/421/6/062017
- [11] Semenikhina, Y., Kambulov, S., Boyko, A., Nadolinsky, Y., Podlesniy, D.: Influence of the main tillage methods on the moisture temperature mode of the soil and the yield of winter wheat, in: *IOP Conference Series: Earth and Environmental Science*, Vol. 723 (3), Article Number 032048, 2021, doi:10.1088/1755-1315/723/3/032048
- [12] Kokoshin, S.N., Kirgintsev, B.O., Tashlanov, V.I.: Disc seeder with auto tracking system depth of sowing seeds, in: *Journal of Physics: Conference Series*, Vol. 1614 (1), Article Number 012051, 2020, doi:10.1088/1742-6596/1614/1/012051
- [13] McLaughlin, N.B., Campbell, A.J., Owen, G.T.: Performance of hoe and triple disc furrow openers on no-till grain drills in a fine sandy loam soil, in: *Soil and Tillage Research*, Vol. 195, Article Number 104373, 2019, doi:10.1016/j.still.2019.104373
- [14] Zubarev, A.G., Laryushin, N.P., Kukharev, O.N.: Innovative grain seeder coulters, in: *IOP Conference Series: Earth and Environmental Science*, Vol. 839 (5), Article Number 052032, 2021, doi:10.1088/1755-1315/839/5/052032
- [15] Shepelev S.D., Pyataev M.V., Zyryanov A.P., Kravchenko E.N.: Theoretical and experimental studies of following the soil microrelief contour by the seeder section, in: *IOP Conference Series: Earth and Environmental Science. International Scientific and Practical Conference: Development of the Agro-Industrial Complex in the Context of Robotization and Digitalization of Production in Russia and Abroad (DAICRA 2021)*, Vol. 949, Article Number 012132, 2022, doi:10.1088/1755-1315/949/1/012132
- [16] Sharipov, G.M., Paraforos, D.S., Griepentrog, H.W.: Validating the model of a no-till coulter assembly equipped with a magnetorheological damping system, *Applied Sciences (Switzerland)*, Vol. 9 (19), No. 3969, 2019, doi:10.3390/app9193969
- [17] Tatarov, G., Kurdumov, V., Sharonov, I. The study of the working body of the sowing complex in flowvision, in: *E3S Web of Conferences*, Vol. 126, Article Number 00028, 2019, doi:10.1051/e3sconf/201912600028
- [18] Kurushin, V., Kurdumov, V., Sharonov, I.: Development and justification of the parameters of the coulter group of grain drills, in: *E3S Web of Conferences*, Vol. 126, Article Number 00042, 2019, doi:10.1051/e3sconf/201912600042
- [19] Aikins, K.A., Antille, D.L., Jensen, T.A., Blackwell, J.: Performance comparison of residue management units of no-tillage sowing systems: A review, *Engineering in Agriculture, Environment and Food*, Vol. 12, No 2, pp. 181-190, 2019, doi:10.1016/j.eaef.2018.12.006
- [20] Solodun, V., Boyarkin, E., Zaitsev, A., Amakova, T.: Efficiency of Applying Sowing Machines for Planting Spring Wheat in the Irkutsk Region in: *Fundamental and Applied Scientific Research in the Development of Agriculture in the Far East. Agricultural Innovation Systems, Vol.1*, pp. 131-137, 2020, doi:10.1007/978-3-030-91402-8\_16
- [21] Nesmiyan, A., Ivanov, P., Kravchenko, L., Arzhenovskiy, A., Globin, A.: Evaluation of Technical Characteristics and Agrotechnical Performance Indicators of Seeders of Various Assembling, in: *Fundamental and Applied Scientific Research in the Development of Agriculture in the Far East. Agricultural Innovation Systems, Vol.1*, pp. 88-101, 2022. doi: 10.1007/978-3-030-81619-3\_10
- [22] Nuralin, B., Galiev, M., Kubasheva, Z., Kozhabergen, O., Khairullina, S.: Study of Combined Tool Tiller Modes Intended for Graded Tillage, *FME Transactions*, Vol. 49, No. 2, pp. 463-471, 2021, doi:10.5937/fme2102463N
- [23] Gabdrāfikov, Fanil Z., Shamukaev, Sergey B., Gaisin, Elmir M., Safina, Rimma R.: Mathematical

Description of the Machine-Tractor Aggregate Diesel Engine with Electronic Positional Impact Regulator, FME Transactions, Vol.46, No4, pp. 469-474, 2018, doi:10.5937/fmet1804469G

- [24] Troyanovskaya, I., Zhakov, A., Grebenshchikova, O., Voinash, S., Timofeev, E.: Directional Stability of an Agricultural Tractor, FME Transactions, Vol. 49, No2, pp. 456-462, 2021, doi: 10.5937/fme2102456T
- [25] Kim, Y.S., Kim, W.S., Baek, S.Y., Baek, S.M., Kim, Y.J., Lee, S.D.: Analysis of tillage depth and gear selection for mechanical load and fuel efficiency of an agricultural tractor using an agricultural field measuring system, Sensors, vol. 20, No. 9, Article Number 2450, 2020. doi.org/10.3390/s20092450.
- [26] Ivanov, A., Puzyrev, M.: Rotary working body of the tillage machine, in: *IOP Conference Series: Earth and Environmental Science*, Vol. 403(1), Article Number 012177. doi:10.1088/1755-1315/403/1/012177
- [27] Kazakov, Y.F., Medvedev, V.I., Ivanov, V.M.: On the development of combined tillage working bodies mechanisms, in: *IOP Conference Series: Earth and Environmental Science*, Vol. 433(1), Article Number 012019, doi.org/10.1088/1755-1315/433/1/012019
- [28] Lachuga, Y.F., Akhalaya, B.K., Shogenov, Y.K.: New designs for universal workingbodies of tillage and seeding equipment, *Russian Agricultural Sciences*, vol. 45, No5, pp. 498–502, 2019, doi.org /10.3103/S1068367419050100.
- [29] Ding, R.: Study on measuring system of tillage depth of deep loosening machine, *Journal of Computational Methods in Sciences and Engi-*

neering, Vol. 17, No 3, pp. 473-480, 2017, doi:10.3233/JCM-170733

---

## СТУДИЈА ВУЧНОГ ОТПОРА ОДСЕКА ЗА САДЊУ БЕЗ ОБРАДЕ

С. Шепевелев, М. Пјатајев, Е. Кравченко

У раду су приказани резултати проучавања вучног отпора комбиноване сетвене секције за но-тилл технологију сетве. Сетвени део се састоји од диска за урезивање, сидреног колектора и притиска. Да би се обезбедила стабилност кретања распршивача, секција има паралелограмско ослањање и точак за балансирање на који делује подесива вертикална сила у зависности од отпора земљишта и дубине обраде. Сетвени део обезбеђује да се семе засеје на задату дубину у влажном слоју земље према агротехничким захтевима. На основу теоријских студија добијена је аналитичка зависност која омогућава одређивање вучног отпора појединих алата и сетвене секције у зависности од конструкцијских и радних параметара. У раду су приказани резултати експерименталних испитивања динамометарског испитивања сетвене секције у лабораторијским условима. У ту сврху коришћени су аналогно-дигитални мерно-рачунарски комплекс и софтверски пакет за постексперименталну обраду експерименталних података. Добијене су експерименталне зависности вучног отпора појединачних алата и пресека за сејање уопште, што потврђује исправност теоријских студија. Приближно је одређена називна вучна сила трактора и приказани су резултати лабораторијско-пољских и пољских огледа са сетвом.