

# Timing Chain Wear Investigation Methods – Review

**László Paulovics**

Assistant lecturer  
Széchenyi István University  
Audi Hungaria Faculty of Automotive  
Engineering  
Department of Internal Combustion Engines  
and Propulsion Technology  
Hungary

**Jan Rohde-Brandenburger**

Head of Department  
Széchenyi István University  
Audi Hungaria Faculty of Automotive  
Engineering  
Department of Internal Combustion Engines  
and Propulsion Technology  
Hungary

**Csaba Tóth-Nagy**

Associate professor  
Széchenyi István University  
Audi Hungaria Faculty of Automotive  
Engineering  
Department of Internal Combustion Engines  
and Propulsion Technology  
Hungary

*Several methods are used for investigating timing chain wear, from fired engine dynamometer tests through tribological model tests to simulations. Research over the past decade has shown that component or tribometer tests can replace expensive engine dynamometer tests in many cases. Simulation methods can further reduce the cost and time of development. Simulation models require experimentally defined input parameters; therefore, experiment-based methods cannot be completely avoided. However, a comprehensive comparison or validation of the various experimental and simulation techniques is difficult, as the literature on the topic is relatively scarce. This study aims to give a systematic comparison of the results of several investigation methods of timing chain wear, supported by data measured at Széchenyi István University, such as fired engine dynamometer tests, cold dynamometer tests, component tests, and tribometer tests, presenting their benefits and limitations, where possible through examples and results. The study also provides an insight into the compatibility of different measurement methods.*

**Keywords:** internal combustion engine, tribology, wear, timing chain, tribometer, chain test bench, radionuclide technique

## 1. INTRODUCTION

Nowadays, the automotive industry is undergoing a revolution, with technology changing at an unprecedented rate, more and more hybrid and electric cars appear on the roads [1],[2]. Internal combustion engines are expected to be present for many more years in most newly registered vehicles, at least as part of the hybrid powertrain, as it will take years to develop the extensive infrastructure needed to electrify the public transport fully and to adapt the global electric network to that [3],[4].

In addition, the intensifying global shortage of raw materials and inflation in recent years will slow down the spread of electric vehicles [2].

Therefore, reducing emissions of new internal combustion engines remains an important task. This can be achieved on the one hand by increasing the efficiency of engines [4]-[6] and on the other hand by using CO<sub>2</sub>-neutral fuels [6]-[9]. Efficiency of the engines can be increased by improving the combustion process or by reducing the engines' internal losses, such as pumping and friction losses. In order to reduce the internal friction of engines, the quality of lubricating oils used in passenger car engines has also changed significantly in the last 20 years. In several steps, the automotive industry has moved from the commonly used 10W-40 viscosity class to 0W-30 and then to 0W-20 viscosity [10]. In the coming years, the viscosity classes 0W-16 and 0W-8 are expected to become more widespread. At the same time, the specific load on

engines and thus on engine oil has increased significantly due to the downsizing trend of the last decades. In addition to the mechanical and thermal load, the fuels also significantly impact the aging of the lubricating oil and thus the tribology of the engine [11]-[14]; therefore, newly introduced CO<sub>2</sub>-neutral fuels should also be considered in this light.

In the case of using new types of engine oils and fuels, tribologically sensitive components require special attention. Such components are turbocharger bearings, connecting rod bearings, and the timing chain. Wear rate is a critical property of timing chains because they are expected to serve the entire life of the engine [15]. Therefore, it is also necessary to check the effect of changes in the oil quality on the chain wear and the factors influencing the oil aging and contamination, such as the combustion process and fuel itself.

## 2. TIMING CHAIN WEAR AND ITS CONSEQUENCES

In passenger car engines, belts or chains are most commonly used to drive camshafts. Their proportion is about 50-50%. A chain drive is slightly more expensive but also safer than a belt drive, it can be used at higher loads and higher engine speeds, and it lasts the entire lifetime of the engine [15].

In internal combustion engines, three main chain types are used as timing chains (and to drive other components, such as oil pump, water pump, fuel pump, and balancing shaft): bush chain, roller chain, and toothed chain (silent chain). All three types of chains have their advantages and disadvantages. The bush chain (Figure 1/a) is heavy-duty and durable but noisy, while the toothed chain (Figure 1/c) is silent (that is why it is called a silent chain) but has higher friction loss and higher wear. The roller chain (Figure 1/b) can be considered a compromise between the other two [16],

Received: April 2022, Accepted: July 2022

Correspondence to: Dipl.-Ing. Paulovics László,  
Assistant lecturer, Széchenyi István University, 9026  
Győr, Egyetem tér 1. Hungary  
E-mail: paulovics.laszlo@sze.hu

doi:10.5937/fme2203461P

© Faculty of Mechanical Engineering, Belgrade. All rights reserved

FME Transactions (2022) 50, 461-472 461

but its use is relatively rare. Bush chains are typically used in diesel engines, and toothed chains or roller chains are usually used in gasoline engines [17].

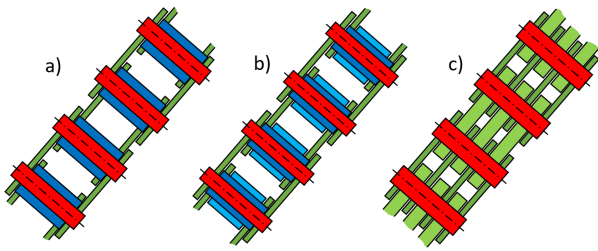

**Figure 1. Timing chain types: a) bush chain, b) roller chain, c) toothed chain (silent chain)**

The wear of the chain elements is a critical issue not only for the lifetime of the chain but also for the engine's operation, as wear causes chain elongation due to the increasing play between the chain links. Chain wear occurs at the joints, i.e., between the pin and the bush (in the case of toothed chains, between the pin and the moving plates). The small angular swivel motion of the joints leads to a boundary friction regime, making the chain joints more sensitive to oil quality and contamination.

The length of the chain changes, causing a delay in valve timing. (Elongation due to wear cannot be compensated by the chain tensioner. The tensioner can only reduce vibrations). Valve timing delays in diesel and gasoline engines impair the engine functions: gas exchange, power, fuel consumption, and emissions. In modern internal combustion engines, a maximum valve timing deviation of 1-1.5 °CA (crank angle) is permitted [15]. High wear (chain elongation of a few mm) can also cause a large (5-8 °CA) delay in the valve timing, which is especially dangerous for diesel engines. Due to their high compression ratio, pistons go very close to the opening intake and closing exhaust valves. And due to a significant delay in valve timing, pistons can hit the exhaust valves closing late. This can cause severe engine damage.

In case of heavy wear, the chain will no longer fit properly on the sprockets, making its operation increasingly noisy. In addition, there is a risk that the chain will skip one or more teeth on the sprocket due to a sudden change in load, which can result in a rough delay in valve timing and heavy engine damage due to a collision between the valves and the pistons.

In extreme cases, chain breaks can also occur due to excessive chain wear. To avoid these problems, the manufacturers specify that a maximum elongation of 0.3-0.5 % is allowed during the lifetime of the chain (approx. 250-300,000 km for passenger cars). If this is exceeded, the chain must be replaced [15],[17].

The lifetime critical wear rate is 10 nm/h for an average timing chain. This comes from the following: timing chains are usually made with 6-10 mm pitch and consist of 150-180 joints, which means a total length of 900-1800 mm. Over the lifetime of a chain, which is usually 300,000 km, or roughly 5,000 operating hours, an elongation of 0.5% is generally allowed [17]. For example, a chain with 9 mm pitch and 170 joints elongates 7.65 mm over a total length of 1530 mm. Divided into 5000 hours and 170 chain links, this gives

an average wear rate of 9 nm/h. Thus, average chains must produce a mean wear rate below 8...10 nm/h to meet the expected lifetime. In comparison, most timing chains show a wear rate below 2 nm/h under normal operating conditions when the lubricant is in good condition [18].

Due to the former, it is necessary to be aware of the life expectancy of the chains and the effect of various conditions and factors on wear. Therefore, during the development of timing chains, engines, and engine oils, the wear of timing chains under different conditions must be studied [19],[20].

There are several levels of tribological tests to choose from, from model tests to field tests, as described in DIN 50322 [21]. In the practice, various engine dynamometer tests [13]-[18],[22]-[28] and component tests [17],[26],[29]-[33], are typically used, and in some cases also tribometer tests [33] are common.

The following chapters provide an overview of the methods used to wear testing of timing chains, highlighting each method's advantages, disadvantages, applicability, and limitations.

### 3. CHAIN WEAR MEASUREMENT

Chain wear is measured using custom-designed gauges that measure chain elongation (see Figure 2). They are based on a high-rigidity frame and usually are supplied with two adjustable discs. These two discs are manufactured with strict tolerances for each type of chain because chain manufacturers prescribe customized discs for measuring the length of various species of chains. After placing the chain on the discs, it is tensioned with a defined force, and the distance between the discs is measured with a dial gauge or using an optical method. From the change of the distance, the total elongation of the chain or its projection on a single joint can be calculated [15]. Other chain elongation measuring devices are also used, that grip only a segment of the chain and measure it in a prestressed state [29],[32]. The result can then be projected to full chain elongation [35]. More detailed information can be obtained using tactile measurement of the pins and the bores of the bushes [13],[29],[35], but this is quite time-consuming and can only be achieved at the cost of final disassembly and destruction of the chain, so it is not suitable for wear monitoring during a test.

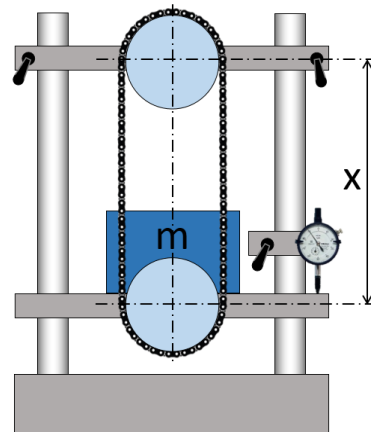

**Figure 2. Chain elongation measurement device**

## 4. FIELD TESTS

Field tests are usually infrequent, as they test the complete product under real operating circumstances. Vehicles undergo a long-term test on public roads or a test track, at the end of which the engine is disassembled, and the timing chain wear is measured, as described in chapter 3. Such tests perfectly match real-world use, but due to their nature, many stochastic influencing factors make them difficult to repeat. In addition, they are extremely time-consuming and expensive because it is impossible to accelerate aging and wear. If this were done, the original benefits of this investigation method would be lost. For this reason, such tests are typically performed only in the final stage of the development of a product, for verification purposes before production begins [15],[21].

## 5. FIRED ENGINE DYNAMOMETER TESTS

Engine dynamometer tests are required during the development of most engine parts because all components or modifications on them must be tested in the engine before the start of production. They are usually subjected to higher load and more intensive use than expected during real use to model the worst-case scenario, accelerate component aging, and save time and money.

### 5.1 Engine test with periodic wear measurements

On an engine dynamometer, engines can operate continuously under high loads, even under higher loads or in more extreme conditions than can be created in a vehicle. During an endurance test, the wear of the parts is traditionally checked by periodic wear measurements (e.g., every 100 hours). This requires the test to be interrupted and the engine disassembled to check the chain wear with the methods presented in chapter 3. Due to the periodic engine disassembly, this is quite a time-consuming procedure. In addition, it can take several hundred or thousands of hours to generate well-measurable wear, making the comparison possible across different variables. An additional drawback is that directly after periodic disassemblies and reassemblies, the wear of the parts temporarily increases due to a re-running-in process [13]. This drawback can be avoided by online wear measurement [28].

### 5.2 Online wear measurement using radionuclide technique (RNT)

Radionuclide technique (RNT) [40] was developed in the 1970s to measure component wear online at high resolution (0.1 nm/h). As a result, it is not necessary to test parts until they completely wear out, it is sufficient to measure the wear for a few hours at each operating point to determine its characteristic wear rate. The technology's essence is that the tested component's wearing surface is activated, i.e., radioactively marked at a depth of a few 10 micrometers. The effects of the activation on the physical and chemical properties of the material are negligible. Suppose the tested component works in the engine oil circuit. In that case, the filter concentration measuring method can be used, which measures the activity of the radioactive particles

transported to the oil chambers of the detectors by the oil. The other solution is the thin-layer difference method, in which the decreasing activity of an activated part due to wear is measured. In the case of a timing chain, the first solution is used because the chain works in the oil circuit of the engine.

In the case of RNT wear measurement on a chain, the wearing surfaces (the pins and the bores of the bushes or plates) of some chain links are activated before the chain is assembled. (To ensure the factory quality, cooperation with the chain manufacturer is essential here, as the pieces must be activated before assembling the chain at the factory.) The chain is then installed in the engine, and after a calibration procedure, the test will start with a running-in program, during which the wear is already measured. Radioactive wear particles get into the engine oil and mix in the whole oil system, where they can be detected.

The measuring system (Figure 3) includes two measuring heads using NaI scintillators to detect radioactivity. (A scintillation detector is a type of nuclear detector that converts the kinetic energy of charged particles into a scintillation, i.e., a flash of light [41].) One of the measuring heads contains the engine oil filter that has been moved outside the engine. On the engine, the filter is replaced by an adapter that directs the oil into the filter placed in the measuring head using the engine's oil pump. The detector in the filter measuring head measures the activity of radioactive wear particles accumulating in the filter. A second measuring head is also required to detect smaller wear particles that can pass through the oil filter. For this is the flow-through measuring head, which measures the radiation of a given volume of oil, which is proportional to the concentration of smaller radioactive particles. This measuring head has its pump to circulate the oil, which is tapped from the prepared oil sump of the engine through a pipe, and after the measurement, it returns there through another pipe. The sum of the activity measured by the two measuring heads gives the cumulative value of the total wear and the time-derivative, which is the wear rate. For developers, the latter value is more important because it can be used to compare different operating points and different environmental and lubrication conditions.

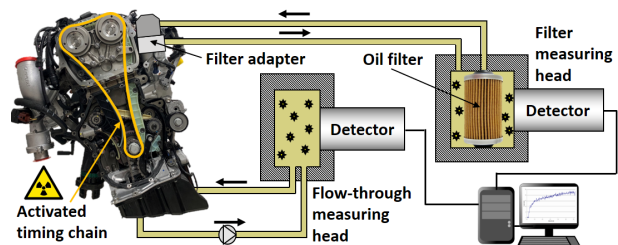

**Figure 3. Online wear measurement of a timing chain using an RNT measuring system**

The wear rate can be determined with high certainty by measuring a given stable operating point for 2-3 hours. With this method, the wear over the whole engine map can be measured and compared under different conditions, just in a few weeks, which would be the multiple of time by periodically removing the chain and measuring its elongation.

The disadvantages of RNT wear measurements are that the components have to be activated, which is very expensive, a qualified isotope laboratory is required to perform the test, and then the handling and safe storage of the radioactive waste must be ensured for several years. (Measuring isotopes, such as Co-56, Cr-51 usually have a half-life of a few weeks, so these components become completely harmless after a few years.)

### 5.3 Wear measurement on timing chains using the radionuclide technique (RNT)

Schwarze et al. [13] investigated the effect of blow-by gases on the oil aging in a running gasoline engine at various temperatures. Wear was measured on the pins of an activated timing chain with the radionuclide technique. The timing chain was also removed every 100 hours, and geometric measurements verified the online measurement.

The 500-hour dynamometer test program simulated real-world use and included urban (low load, frequently stopped engine) and highway (higher load, intense accelerations) phases in a 6:1 ratio. The test program was performed in cold running (oil conditioned to 20 to 50 °C) and hot running (oil conditioned to 110 to 140 °C). In addition, the cold and hot running was performed with original and modified blow-by systems. In the latter case, an attempt was made to separate the blow-by gases as far as possible from the engine oil circuit and to extract them from the crankcase.

The results showed that with the original blow-by system, the total wear of the chain was in cold running 10 times as high as in hot running, despite one-third as many roll-overs, i.e., wear rate was about 30 times as high for the same distance projected. With the modified blow-by system, the wear decreased by one-half in cold running but did not change in hot running. This was confirmed by surface analysis: the average wear depth of the pins after 500 hours was 3 µm after hot runs, 15 µm after a cold run with the original blow-by system, and 7 µm after a cold run with extracted blow-by gases.

The reason for the difference is that at low temperatures, water, acids (sulfuric and nitric acids), and fuel condense from the blow-by gases. Acids are highly corrosive and, together with water, attack metallic surfaces and oil. The fuel dilutes the oil, and decreases its viscosity which significantly impairs its lubricity. Water emulsion, acidic contaminants, and oil degradation can be reduced by extracting blow-by gases, but fuel dilution persists.

In another study, Schwarze et al. [14] examined the effect of E85 fuel running a gasoline engine using a dynamometer program similar to the previous one. Also, they examined the wear of the chain pins with RNT wear measurement. Tests have shown that E85 increases the wear of chain pins in cold running by 20% compared to RON95 fuel. In the case of hot running, the wear increases significantly; in this case, the wear is about 30% higher with E85. The cause of increased wear in hot operation is the cavitation of the fuel in the oil, which occurs in the chain joints.

Gergye et al. [23] at the Department of Internal Combustion Engines and Propulsion Technology at Széchenyi István University compared the wear on the timing chain of a gasoline engine using new and used oil (15,000 km) and at different operating temperatures in a series of tests. In the toothed chain, the circumferential surface of two pins were activated at 360° and the bores of 4-4 moving plates at 90° on the loaded side. The series of experiments has shown that chain wear increased in proportion to engine speed and load. Using used oil, the wear on the vanadium-coated pins doubled on average, and the wear on the uncoated plates increased ten times on average. The effect of temperature was also detectable on wear; at 120 °C, oil temperature had slightly higher wear than at 90 °C, but this difference was not significant for chain lifetime.

In another series of experiments, Paulovics et al. [18] at the Department of Internal Combustion Engines and Propulsion Technology at Széchenyi István University investigated the wear of a diesel engine's timing chain with various new and used engine oils. During the series of experiments, the timing chain wear was measured using various oils: new 0W-20, new 0W-30, and a used version of the same 0W-30 oil from a 200-hour engine dynamometer test (equivalent to about 15,000 km, which is the prescribed oil change interval for this engine). In the bush chain, 10 pins and the bore of 10 sleeves were activated with two different isotopes over the entire circumferential surface so that the value of the measured wear was the average over the whole circumference for both the holes the pins.

During the test, the engine was exercised at a relatively high load (50 and 100% throttle position) and in a relatively high-speed range (1250-4000 rpm), i.e., at a higher load than the average real-world operation. All the operating points were measured 3 hours long to have a stable and reliable wear rate. Wear of the bushes was presented at 5 different speed/load operating points with all three oils. The result was a wear rate of 0.5 to 0.8 nm/h at all operating points with both types of fresh oil, which are sufficiently low values. With the 200 hours used 0W-30 oil, the chain wear increased significantly, producing wear rates ranging from 7.2 to 11.2 nm/h at various operating points, more than ten times the values measured with new oils.

Conclusions from the presented studies are that the type of fuel used, the engine's use, fuel dilution from engine operation, soot content, and oil aging strongly influenced the wear of timing chains. Tests on both gasoline and diesel engines, equipped with bush and toothed chains, have shown that aged, degraded, acidified, heavily soot-contaminated, and with water and fuel diluted oils can increase wear by more than 10 times.

Radionuclide technique has significantly reduced the time and cost of engine dynamometer tests required for wear measurement.

However, the price of the above results was several 100 hours of engine dynamometer tests and several 1000 liters of fuel consumed. The cost of radioactive activation is also significant. It is typically in the order of the price of the fuel consumed during the tests. It is, therefore, worth considering whether simpler tribo-

logical tests or simulations can replace engine dynamometer tests.

## 6. COLD ENGINE DYNAMOMETER TESTS

Timing chains are often tested in engines without combustion to determine noise levels, friction losses, or wear. Such tests are often used by the automotive industry and its supplier industry [16],[17],[20],[27], as well as by universities and research institutes [25],[26], because they can provide important information about friction losses, wear, vibrations and noise in the engine. Although the amplitude of the load on the chain without combustion is smaller, the forces acting on the chain during one revolution are close to real operation. The only significant difference is the excitations originating from combustion events [27]. Consequently, this method is suitable for comparing different chains and oil qualities in a given engine.

At the Department of Internal Combustion Engines and Propulsion Technology at Széchenyi István University, two-timing chains of different manufacturers were compared on a cold test engine dynamometer. The test's purpose was to verify if the two products show a significant difference in wear, i.e., if the chains are interchangeable. The two different chains were tested in an externally driven gasoline engine lubricated with different used oils at dynamically varying speeds between 1000 and 6000 rpm for more than 1000 hours per chain. Both chains were disassembled from the engine every 100 hours to measure chain elongation in a measurement device described in chapter 3. Results showed a small difference between the timing chains of the two manufacturers. The total elongation of the chains was 0.81 mm and 1.01 mm after 1000 hours.

In addition to periodic elongation measurements, chain elongation was reliably monitored by measuring the position of the chain tensioner at stable operating points, using a laser vibrometer. Results obtained from the vibrometer measurements and chain elongation measurements were comparable.

This test is significantly less expensive than a fired engine dynamometer test with RNT wear measurement. In addition, there is no fuel consumption, which decreases the environmental impact of the test significantly. However, it is a disadvantage that the load on the components is about half without combustion, so wear is slower. Due to the design of its (usually open) oil circuit, the cold test engine dynamometer is not suitable for using radionuclide technology; therefore, a conventional chain elongation gauge (see chapter 3) must be used that can only reliably measure higher wear, that requires hundreds of operating hours.

## 7. CHAIN TEST BENCHES

Drive chain manufacturers and research institutes often use component test benches to test chains [15]-[17]. The tests aim to investigate the chains' friction losses, wear, or acoustic characteristics. Depending on the purpose, the construction of test benches also varies, but, commonly, an electric motor drives the timing chain.

The implementation of the load and the installation of the chain and its peripherals can be different.

When the goal is to optimize the chain for a given internal combustion engine to minimize noise and friction, the complete chain drive with chain guides and tensioner is typically built on a rigid frame in a geometric arrangement appropriate to the engine. The chain is then subjected to a dynamic load by driving the complete valve train in a cylinder head or by a similar dynamic load [17],[25].

Test benches with a simpler layout – typically without chain guides – are generally used to test the wear resistance. Wear is usually generated by a constant tensioning force/torque. The chains are usually tested in pairs, mounting two chains at a time at the sprockets placed on the ends of the driving and the driven shafts (see Figure 4). Tensioning can be realized by moving one of the shafts [42],[43], rotating the two sprockets on the driven shaft relative to each other [29],[31],[35],[37], or by synchronous use of two electric motors when one motor drives and the other one brakes through the chains [31]. The main difference between the methods is that both spans of both chains are tight when having a steady force on the movable shaft (Figure 4/a), while one span of each chain will be tight and the other will have a slack by rotating the sprockets relative to each other (Figure 4/b) or using two synchronized electric motors when one motor drives and the other one brakes through the chains [31]. The latter two solutions are more complicated to implement, but they are closer to the real operational circumstances of the chain. Using version b), the sprockets can be rotated using a mechanical [29],[31],[35], or hydraulic [37] device (marked by C in Figure 4/b). Using a mechanical coupling, tensioning the chains against each other is defined at the beginning of the experiment, but while the chains wear, the tensioning force also decreases continuously [31],[35]. However, a hydraulic tensioner keeps the load constant at all times, regardless of wear [37].

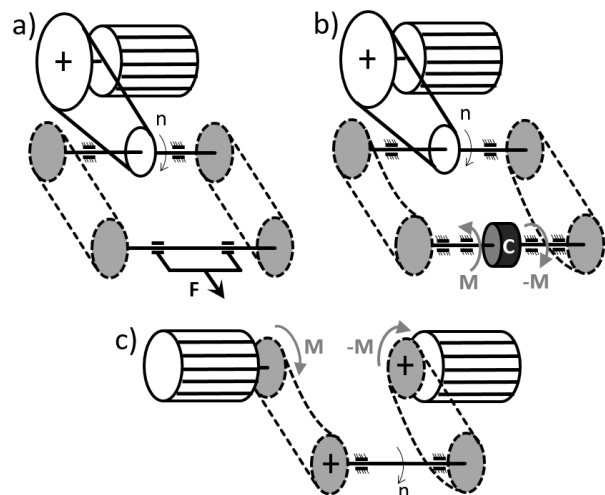

Figure 4. Tensioning methods on-chain test benches

The advantage of component benches is that complete chains can be tested together with sprockets. Load is simplified compared to engine tests, but the costs of the tests are also significantly lower. At the same time, the load can even be increased compared to the load in an engine, so that wear can be accelerated.



Such component test benches are suitable for determining differences in chain design or lubricant quality while testing the chains independent of engine type. Tests can take days or weeks, depending on the wear rate, but they require significantly less human supervision than an engine dynamometer.

Measurements on component test benches have to be interrupted at regular intervals to measure the chain elongation. However, these interruptions can be avoided if the test bench is equipped with a position or angle sensor with sufficient accuracy to measure the elongation of the chains during operation [37].

## 8. COMPONENT TESTS ON TRIBOMETER

Tribometers are most often used for basic research and testing of lubricants using standard test specimens [44]-[48]. In addition, most tribometers are suitable for individual test specimens that are machined from the real machine or engine components. Piston ring-cylinder wall pairing is often used [49],[50] to compare different material qualities, surface technologies, coatings, or lubricants because it is orders of magnitude faster and more economical than engine dynamometer tests. Component tests obviously cannot substitute engine tests, but the number of variations tested on an engine dynamometer can be significantly reduced.

It is also possible to use tribometer tests in the case of timing chains. Usually, a single joint of the chain is tested on the tribometer. In the case of a bush chain, this means a pin and a bush, but the assembly can be done according to several versions, e.g., as a pin-in-bush (like in the original chain joint) or bush-on-pin configuration, as it can be seen in Figure 5.

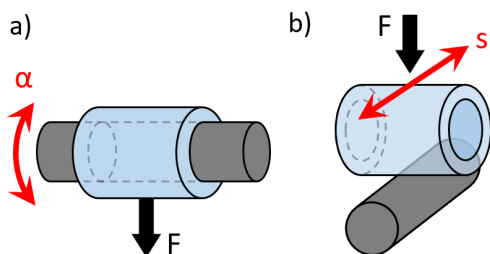

**Figure 5. Chain specimen configurations on tribometer: a) pin-in-bush, b) bush-on-pin**

### 7.1 Chain joint tribometer (pin-in-bush test)

The clear advantage of a pin-in-bush configuration is that it examines the chain joint in a real-like assembly with a real-like load. That is why it is also called a chain joint tribometer. Due to their design, its disadvantage is that existing universal tribometers are generally unsuitable for this type of chain installation. In addition, it should be noted that any geometric deviations of the pins and bushes (even within the manufacturing tolerances) affect the result. These effects can be reduced by sorting the specimens, using more repetitions, or individually adjusting the specimens within the tribometer [35].

At the University of Kaiserslautern, a chain joint tribometer was developed [29],[34],[35], where one joint of a bush chain can be tested in a realistic configuration (Figure 5/a) with a realistic load. A chain

segment containing 4 pins is required to ensure a secure grip and load, but only one joint is tested. A highly dynamic electric motor provides the small angular swivel movement of the tested joint and a linear actuator ensures the tensioning force. Friction torque and wear can also be measured online, the latter by measuring the displacement in the direction of the tension. With the chain joint tribometer, it is possible to apply stationary and dynamic load with varying swivel angles so that a realistic load of a single chain joint during a chain roll-over can be well simulated. This real-like swivel angle and tensioning load functions can be determined using multi-body simulation (MBS) [35]. The operating principle of the tribometer is illustrated in Figure 6.

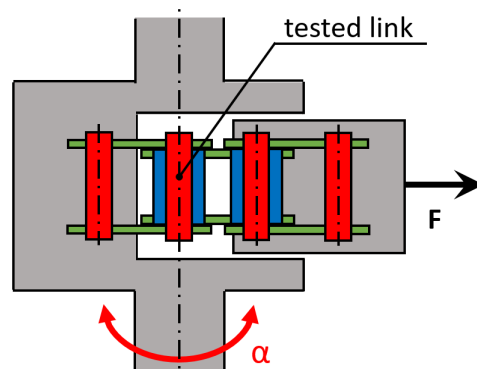

**Figure 6. Schematic setup of chain joint tribometer**

The chain joint tribometer is particularly useful in developing chains because an experimental solution (e.g., chain components with a new coating, surface treatment, or microstructure) does not require the production of large quantities of pins and bushes and the assembly of complete chains. At the same time, it is necessary to examine such developments in the assembly of the chain joint; therefore, this can be an optimal solution for the above [35].

Becker et al. [35] validated tests on the chain joint tribometer by testing the same chain type on their own chain test bench (see chapter 7.). Chains were run on the chain test bench at 500 rpm with a tensioning torque of 40 Nm for 100 hours. On the chain joint tribometer, the chain joint was subjected to an equivalent load, i.e., a rotation and load function were prescribed that reproduce the load of a single chain joint of a chain on the chain test bench during a chain roll-over. The varying load simulates a single joint under load in both the tight and the slack chain spans. The swivel function simulates the single joint running up and down the sprockets.

Wear showed very similar results on the chain joint tribometer and the chain test bench. The wear rate and distribution on the bushes and pins were almost identical using the two methods. A difference occurred during the running-in phase, during the first 20 hours, because more intense running-in wear occurred in the chain joint tribometer. Its main reason is that the joint in the tribometer cannot move during the running-in process due to the rigid grip, and there is also some simplification in the load function.

Overall, the chain joint tribometer is able to approximate the real circumstances very well.

## 7.2 Bush-on-pin tribometer test

The bush-on-pin configuration is farther away from the real system than the pin-in-bush configuration (chain joint tribometer) because the pin is in contact with the outer surface of the bush, and this contact is point-like. Its advantage is that most of the existing reciprocating tribometers are suitable for this setup, which only requires the design of a custom adapter, so there is no need to develop or purchase a custom tribometer for this purpose.

An additional advantage of this configuration is that due to the point-like contact, form deviation and surface structure have less influence on the operation of the tribological system [33]. Although the absolute value of friction and wear does not correspond to reality, the difference in wear (e.g., when comparing different oil qualities) reflects the real conditions. Therefore, this configuration is suitable e.g., for ranking oil grades, taking the original material of the chains into account.

Sappok et al. of the University of Kaiserslautern [33] and Paulovics et al. of Széchenyi István University [18],[36]-[39] performed experiments independently with bush-on-pin configuration (Figure 5/b); both performed on an existing reciprocating tribometer supplied with a custom adapter. The bush chains examined by the two institutes were different types, differing in size, material quality, hardness, and surface roughness. Furthermore, the test parameters differed, so the results were not directly comparable.

As material quality and surface roughness are critical for wear and friction, the difference between the outer and inner surfaces of the bushes must be checked for each chain type. In the above cases, the hardness of the bushes did not show a significant difference in the outer and inner surfaces, so the bush-on-pin configuration does not differ from the real system in terms of material quality. The surface roughness of the bushes differed significantly only in one case. However, it only has significance at the beginning of the test because wear is very intensive in the first minutes.

At the beginning of the tests, due to point-like contact, the Hertzian stress is much higher than in a real chain joint, but this decreases rapidly because the wear is initially quite high. (High wear rate decreases pressure due to the increased contact area.)

Wear occurs predominantly on the bush because it has a constant contact area, while in the case of the pin it is distributed over the sliding distance (stroke) on the pin's surface. It also has to be noted that the hardness of the pin is usually much higher than the bushes.

Investigations at the Széchenyi István University [18] focused on the effect of oil quality on wear. Using bush-on-pin tribometer tests, different engine oils were compared: new 0W-20, new 0W-30, and a used version of the same 0W-30 oil from a 200-hour engine dynamometer test. These oil samples correspond to the oils used in a previous RNT test (see chapter 5.3), so the results of tribometer tests were also compared with the results of RNT wear measurement performed on the engine dynamometer test. The bush chain and the lubricants tested on the tribometer were identical to those tested on the engine dynamometer [18].

The geometrical difference between the wearing surfaces had to be considered in the comparison. During the RNT test, the wearing surface in the real chain is considered constant so that the wear can be characterized by the average wear rate and the average wear depth. However, for tribometer specimens, the wear scar diameter (WSD) is usually the standard measured parameter [44],[45], but this is not comparable to the wear depth or wear rate measured with RNT. To solve this problem and make the results comparable, it was also required to assess the mean wear depth on the tribometer specimens, which was possible by 3D scanning the wear scars [18]. Unifying the wear parameters in both tests clarified that the wear with the three different oils showed a very similar ratio when comparing the mean wear depth in the case of the tribometer and RNT tests (Table 1).

**Table 1. Comparison of chain wear results measured on tribometer and engine dynamometer**

Oil	Bush-on-pin tribometer test		RNT chain wear measurement
	Wear scar diameter	Mean wear depth	Mean wear depth (mean wear rate)
0W-30	100%	100%	100%
0W-20	96%	85%	86%
0W-30 200h	249%	1018%	1167%

Based on the results shown in Table 1, it can be stated that the bush-on-pin tribometer test is suitable for assessing the effect of oil quality on chain wear and comparing oil qualities, but the method of wear measurement or wear calculation strongly affects the reliability of the results [18],[46].

## 9. MODEL TESTS ON BALL-ON-DISC TRIBOMETER

Several standardized tribometer tests for investigating lubricating oils are widely used [44],[45]. However, the parameters of these tests (load, temperature, frequency, oil volume, or volume flow) are typically not optimized for engine oils, so institutes specialized in testing engine oils apply individual test parameters [47]-[53].

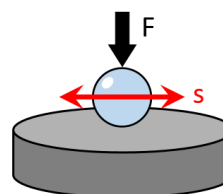

**Figure 7. Ball-on-disc tribometer test**

The ball-on-disc test (Figure 7) is widely used to test engine oils. Its point-like contact, the load, and the lubrication regime that occurs there, as well as the form of the wear scar, are not far from the bush-on-pin tests presented in the previous chapter. The main difference is the material of the test specimens. For ball-on-disc tests, typically lapped discs and polished 10 mm bearing balls are used; both the ball and disc are of 100Cr6 material, according to ISO 19291:2016 [44].

At Széchenyi István University, the bush-on-pin test presented in the previous chapter was compared with

ball-on-disc tests using standard specimens [39]. The study's goal was to assess the similarities and differences in friction and wear between the standard specimens and the chain specimens using the same oil types. Both methods compared three new and pure oils from viscosity grades of 0W-20, 0W-30, and 10W-60, and the same 0W-30 mixed with 0.5 wt%, 1 wt%, and 2 wt% added carbon black (from now on: CB – it is used to substitute engine soot in laboratory tests). The coefficient of friction and wear scar diameter were compared with the two methods. The oil temperature was 100 °C in both cases, but the other test parameters (load, frequency, oil volume, test time) differed.

In terms of coefficient of friction, the 3 uncontaminated oils gave the same order using the two methods: 10W-60 was the best, followed by 0W-20 and then 0W-30. On the other hand, CB-blended oils behaved differently in the two methods. In the case of bush-on-pin, CB slightly reduced the friction, while in the case of ball-on-disc, it increased [39].

Wear showed similar trends to friction. The lowest wear occurred in the case of both methods with 10W-60 oil. 0W-20 and 0W-30 oils followed this. In the case of ball-disc tests, there was a significant difference between them, while the wear on the chain bushes hardly showed a difference using 0W-20 and 0W-30 oils. The difference was within the standard deviation field.

CB-blended oils showed bigger differences in the ball-on-disc test, and the wear was higher even with 0.5% CB than with uncontaminated 0W-30 oil. In contrast, with chain specimens (bush-on-pin), even 1 wt% CB did not increase wear, the increase occurred only by adding 2 wt% CB.

Although the ball-on-disc test provides better repeatability due to the lower standard deviation of the specimen properties, the tribological system does not behave as the system using chain parts. Consequently, over-simplifying the tests and changing the material and surface quality of the specimens resulted in significant differences, especially for contaminated oils. Therefore, it can be concluded that it is not worth simplifying the tests to this level.

The tribological effects of soot have been an intensively studied problem [54]-[57], using standard tribometer specimens in most cases. However, the effect of soot on wear and friction is highly dependent on the given tribological system, so it is more advantageous to test it on specimens machined out of actual components.

The idea may arise that the material or coating used for chain components could be used to make tribometer test specimens with simple geometry. However, this would not guarantee the same material quality as the mass-produced parts [33]. Test specimens would have to be manufactured individually. Therefore lots of parameters, e.g., the rate of heating and cooling during heat treatment, and so the metallographic structure, could differ from the mass-produced parts. In this way, the original goal would not be achieved, only approximated. Moreover, individual specimen production has significant costs, so such tests would not be cost-effective. Instead, it is more advantageous to use mass-produced components (or a part of them) as specimens while adapting the clamping device of the tribometer to them.

## 10. WEAR SIMULATION

Nowadays, computer simulation models are taking over the role of experimental methods in more and more areas of research and development. However, wear is affected by so many factors that it can only be simulated using empirical formulas at the level of larger surfaces or components. This means that the basic wear process must be known to determine the wear volume by simulation. This requires a series of traditional tribological examinations and measurements on the tribological model of the given system [58],[59].

Between the end of the running-in phase and the end of life wear-out, wear processes are generally linear, assuming a permanent contact area. In this phase, the amount of wear depends on the load and the sliding distance. This phenomenon can be well observed using certain tribological model experiments (e.g., pin-on-disc tribometer). Due to the linear nature of the wear process, it can be well simulated and predicted provided that the boundary conditions and the intensity of the process, i.e., the wear coefficient, are known [58],[59].

The wear simulations used nowadays [58]-[65] are based on the wear model of Archard [66]. According to his approach (1), the wear volume ( $V$ ) depends on the load ( $F_N$ ), the relative displacement ( $s$ ), and the hardness ( $H$ ) of the softer material. It also depends on a dimensionless coefficient, a constant characteristic of wear based on observations and measurements. This is the wear coefficient ( $K$ ), which depends on the material properties, the surface quality, the lubricant, the chemical reactivity of the materials, and many other circumstances. Because many factors influence it, practically every tribological system has a unique wear coefficient. Therefore, it can only be determined empirically, typically by tribometer measurements [58],[59].

$$V = K \cdot (F_N/H) \cdot s \quad (1)$$

Wear simulation models work according to the following iteration process [60]:

1. calculation of contact surface and pressure,
2. application of wear model: wear calculation,
3. back to step 1. with the worn surface.

Sappok et al. [33] used a similar wear simulation program for chains, modified the Archard model by taking the contact area ( $A$ ) into account and using an exponent ( $m$ ) due to the nonlinear influence of the force, according to (2).

$$V = K \cdot (F/A)^m \cdot s \quad (2)$$

The steps of Sappok's simulation are the following:

1. calculation of the contact area between the pin and the bush (this depends on the geometry, the mechanical properties of the pin and the bush, and the force distribution along the axis of the pin),
2. calculation of pressure distribution along the contact area,
3. wear volume calculation according to (2),
4. back to step 1. with the worn surface.

The methodology developed by Sappok et al. only calculates the wear of the bush, while it considers the



shape of the pin to be constant, so it can only be used in chains where the wear of the pins is negligible. The calculated wear depends largely on the pressure distribution along the contact area. To define this, a multi-body simulation (MBS) was first used to determine the load on a single chain joint, followed by a FEM simulation to determine the pressure distribution within the joint.

For the simulation, the wear coefficient ( $K$ ) for a given chain and lubricant must be known again. Wear coefficient can be determined by a series of preliminary experiments e.g., on chain joint tribometer or on-chain test bench.

Tandler et al. [65] used a simulation method similar to the previous one, but they used Fleischer's **Error! Reference source not found.** equation (3) as a wear model. According to this, the wear volume ( $V$ ) is proportional to the friction work ( $W_F$ ). The energy density in the denominator ( $e$ ) is the ratio of the friction work ( $W_F$ ) to the wear volume ( $V$ ), which is an empirical value.

$$V = W_F/e \quad (3)$$

This simulation also required data from previous measurements. Friction work was determined on a component test bench [67], and the wear coefficient (which is the reciprocal of the energy density) was determined using RNT wear measurement [65]. During the simulation, it was attempted to prescribe boundary conditions and load that best approximate the operating conditions of the reference chain running 48,885 km in a test vehicle. After the test, the wear of the chain removed from the vehicle was also measured. The wear distribution along the axis and circumference measured on-chain pins was very similar to the wear distribution calculated with the simulation. The maximum wear depth along the axis is also very similar: 6  $\mu\text{m}$  was measured on the chain pin, and 5.028  $\mu\text{m}$  was the simulated value. (Unfortunately, it was not mentioned how many chain pins had been measured; it can only be assumed that the worn pin represents the entire chain).

In summary, with properly constructed simulation models, it is possible to model real processes if sufficient data is available from previous measurements. A simulation is, therefore, a cost-effective tool, but empirical data specific to a given tribological system are essential.

## 11. DISCUSSION

Engine manufacturers work according to strict quality standards and regulations that require newly introduced engine components to undergo various endurance engine tests before they are released into production. These tests have significant cost implications. Therefore, engine tests are the last step of the development process, preceded by a series of simplified component and/or tribometer tests. Engine dynamometer tests are unavoidable, but the application of simpler testing methods can minimize their number. This reduces development time and cost as well as the ecological footprint of the development. Both aspects are of a high priority today.

The present paper reviewed several simplified methods for testing timing chain wear, ranging from testing real and complete chain drives to simple model tests and simulations, emphasizing the advantages, disadvantages, applicability, and limitations of each method and test level. Differences in the results usually originate from the simplification level of the model under focus compared to the real system.

Of the investigations reviewed, Becker et al. [35] demonstrated that the results obtained with the chain joint tribometer and the chain test bench were comparable. Paulovics et al. [18] showed that the results obtained on bush-on-pin tribometer tests corresponded to the wear measured on the timing chain tested in a fired engine in terms of the proportion of wear obtained on various new and used oils. Tandler et al. [65] proved that a well-constructed simulation model could reliably calculate the amount and distribution of wear in a timing chain joint used in a vehicle.

The reviewed methods find their applicability in assessing chain wear with advantages and limitations of their own. The present study helps navigate the methods and the chain wear test applications.

## 12. CONCLUSIONS

After reviewing the literature, simulation models can be concluded to predict the amount of wear over a longer operating time or determine the life expectancy of chains under varying load and speed conditions. However, wear simulation models require an empirically defined wear coefficient that characterizes the given tribological system. Wear coefficients can be determined through tribometer or component tests.

Tribometer tests of on-chain elements were suitable for examining the effect of lubricants and their contamination content. Bush-on-pin tribometer tests proved applicable for determining the effect of oil quality on wear.

Suppose design improvements on the chain are required in response to new boundary conditions. In that case, the chain joint tribometer is a viable option to investigate the effects of different design changes on the wear.

Mass-produced or mass-production-ready chains can be effectively tested under life-like conditions on a component test bench designed for complete chains. Component tests are also used to validate the results of tribometer tests and/or simulation results.

## REFERENCES

- [1] Cui, H., Hall, D., Lutsey, N.: Update on the Global Transition to Electric Vehicles through 2019, International Council on Clean Transportation: Beijing, China, Berlin, Germany, 2020, Available online: <https://theicct.org/publications/update-global-ev-transition-2019> (accessed on 28 February 2022).
- [2] IEA (2022), Electric cars fend off supply challenges to more than double global sales, IEA, Paris, Available online: <https://www.iea.org/commentaries/electric-cars-fend-off-supply-challenges-to-more-than-double-global-sales> (accessed on 22 February 2022).

- [3] Infineum: Driving down energy loss. Infineum Insight, (February 2019), 1–6. Available online: <https://www.infineuminsight.com/en-gb/articles/lubricant-trends/driving-down-energy-loss/> (accessed on 22 February 2022)
- [4] Infineum: Ricardo on future lubricants. Infineum Insight, (January 2019), 1–6. Available online: <https://www.infineuminsight.com/en-gb/articles/lubricant-trends/ricardo-on-future-lubricants/> (accessed on 22 February 2022)
- [5] Hirose, I., Hitomi, M.: Mazda's Way to More Efficient Internal Combustion Engines, *MTZ Worldwide*, 2016 (77), pp. 28-33, 2016.
- [6] Leach, F., Kalghatgi, G., Stone, R., Miles, P.: The scope for improving the efficiency and environmental impact of internal combustion engines. *Transportation Engineering*, 2020 (1), 2020.
- [7] Aakko-Saksa, P., Koponen, P., Roslund, P., Laurikko, J., Nylund, N.-O., Karjalainen, P., Rönkkö, T., Timonen, H.: Comprehensive emission characterisation of exhaust from alternative fuelled cars, *Atmos. Environ.*, 236, 117643, 2020.
- [8] Chen, Y., Ma, J., Han, B., Zhang, P., Hua, H., Chen, H., Su, X.: Emissions of automobiles fueled with alternative fuels based on engine technology: A review. *J. Traffic Transp. Eng.*, 5, 318–334, 2018.
- [9] Niethammer, B., Wodarz, S., Betz, M., Haltenort, P., Oestreich, D., Hackbarth, K., Arnold, U., Otto, T., Sauer, J.: Alternative Liquid Fuels from Renewable Resources. *Chem. Ing. Tech.*, 90, pp. 99–112, 2018.
- [10] Infineum: Moving to even lower viscosities. Infineum Insight, (June 2020), Available online: <https://www.infineuminsight.com/en-gb/articles/lubricant-trends/moving-to-even-lower-viscosities/>. (accessed on 22 February 2022)
- [11] Nagy, A. L. et al.: Artificial Aging Experiments of Neat and Contaminated Engine Oil Samples. *Lubricants* 2021, 9(6), 63, 2021.
- [12] Nagy, A. L., Knaup, J., & Zsoldos, I.: A friction and wear study of laboratory aged engine oil in the presence of diesel fuel and oxymethylene ether. *Tribology - Materials, Surfaces & Interfaces*, 1–11, 2018.
- [13] Schwarze, H., Brouwer, L., Knoll, G., Kopnarski, M., Schlegel, F., Müller-Frank, U., Emrich, S.: Lubricant degradation and wear behaviour in a spark-ignition engine, *MTZ Worldwide*, vol. 69, no. 10, pp. 60–67, 2008.
- [14] Schwarze, H., Brouwer, L., Knoll, G., Longo, C., Kopnarski, M., Emrich, S.: Effect of ethanol fuel E85 on lubricant degradation and wear in spark-ignition engines, *MTZ Worldwide*, vol. 71, no. 4, pp. 56–61, 2010.
- [15] Bauer, P.: *Kettensteuertriebe*, Die Bibliothek der Technik, Band 353, Verlag Moderne Industrie, 2013, (in German)
- [16] Fink, T., Bodenstern, H.: Möglichkeiten der Reibungsreduzierung in Kettentrieben. *Motortechnische Zeitschrift - MTZ*, 72 (7-8), pp. 582-587, 2011. (in German)
- [17] Fink, T., Hirschmann, V.: Kettentriebe für den Einsatz in modernen Verbrennungsmotoren. *MTZ – Motortechnische Zeitschrift* 62, pp. 796–806, 2001. (in German)
- [18] Paulovics, L., Tabakov, Z. M., Tóth-Nagy C., Rohde-Brandenburger, J., Kuti, R.: Comparison of Timing Chain Wear Produced on Engine Dynamometer and Tribometer Using 3D-scanning of Wear Scar, In: Nikodem, J., Klempous, R. (eds.): *12th IEEE International Conference on Cognitive Infocommunications (CogInfoCom 2021) Proceedings, International: IEEE (2021)* pp. 485-490, 2021.
- [19] Shah, R., Gokhale, S. V.: ILSAC GF-6: The highly-anticipated engine oil specification, almost a decade in the making is here, (July 2020), Motorindia. Available online: <https://www.motorindiaonline.in/ilsac-gf-6-the-highly-anticipated-engine-oil-specification-almost-a-decade-in-the-making-is-here/>. (accessed on 16 March 2022)
- [20] Infineum: Timing chain wear, Infineum Insight, (October 2016), pp. 1–6, Available online: <https://www.infineuminsight.com/en-gb/articles/passenger-cars/timing-chain-wear/>. (accessed on 16 March 2022)
- [21] Czichos, H., Habig, K.: Tribologische Mess- und Prüftechnik, in: *Tribologie-Handbuch*, 3. Auflage, Vieweg + Teubner, pp. 193-195, 2010. (in German)
- [22] Dreyer, M. R., Gergye, T.: Tribológiai vizsgálatok belső égésű motorokon, *A jövő járműve*, 2012.1/2, 41-57, 2012. (in Hungarian)
- [23] Gergye, T., Dreyer, M. R., Kehrwald, B., Optatzy, W.: Analysis of the Wear Behavior of Combustion Engine Components Using Radionuclide-Technique, in: SAE-China, FISITA (Eds.): *Proceedings of the FISITA 2012 World Automotive Congress* (1) pp. 171-181, 2012.
- [24] Gergye, T., Dreyer, M. R.: Tribologische Untersuchung einer Steuerkette, in: Dreyer, M. R., Demmelbauer-Ebner, W. (eds.) *2. Győreri Tribologie Tagung*, Győr, Universitas-Győr Nonprofit Kft., pp. 173-186., 2012. (in German)
- [25] Krupp, F., Sauer, B.: Reibungsminderung im Steuerkettentrieb. in: *56. Tribologie-Fachtagung (GfT), 21.-23.09.2015, Göttingen*, Band II, pp. 53/1- 53/11., 2015. (in German)
- [26] Sauer, B., Nicola, A., Flierl, R. et al. Features of timing chain drives, *MTZ Worldwide*, 68, pp. 28–30, 2007.
- [27] Weber, C., Herrmann, W., Stadtmann, J.: Experimental Investigation Into the Dynamic Engine Timing Chain Behaviour, *International Congress and Exposition*, Detroit, Michigan, February 23-26, 1998.
- [28] Kowalski, T. D., Hirano, S., Buscher, W. A., Liu, E., Wang, J. C., Linden, J. L.: Development of a New Valvetrain Wear Test - The Sequence IVB Test, SAE Technical Paper Series. 2016.

- [29] Sappok, D., Sauer, B.: Wear Measurement on Chain Joint Components Using a Roundness Instrument, *Periodica Polytechnica Mechanical Engineering*, 59(2), pp. 51–59, 2015.
- [30] Becker, A., Krupp, F., Sauer, B.: Systematische Verschleißuntersuchungen an Kettenkomponenten, in: *58. Tribologie-Fachtagung (GfT)*, 25.-27.09.2017, Göttingen, 2017. (in German)
- [31] Gummer, A., Fábíán, C., Sauer, B.: Modularer Kettenprüfstand für Verschleiß- und Wirkungsgraduntersuchungen. in: *52. Tribologie-Fachtagung (GfT)*, 26.-28.09.2011, Göttingen, 2011. (in German)
- [32] Gummer, A., Sappok, D., Sauer, B.: Experimentelle und analytische Verschleißuntersuchung von Hülsen- und Rollenketten, in: *53. Tribologie-Fachtagung (GfT)*, 24.-26.09.2012, Göttingen, 2012. (in German)
- [33] Sappok, D., Merz, R., Sauer, B., Kopnarski, M.: Surface Analysis of Chain Joint Components after Tribological Load and Usage of Antiwear Additives, *Conference Papers in Science*, vol. 2015, ArticleID 407048, p. 12, 2015.
- [34] Becker, A., Sauer, B.: Wear investigations on timing chains using a chain joint tribometer. *STLE's 73rd Annual Meeting and Exhibition*, 20.-24.05.2018, Minneapolis, 2018.
- [35] Becker, A., Meffert, D., Sauer, B.: Friction and wear investigations on single chain joints. *Forschung Im Ingenieurwesen*, 83(1), pp. 53–63. 2019.
- [36] Paulovics, L., Tóth, Á. D., Hanula, B., Kopp, A., Knaup, J.: Tribometerversuche an Steuerkettenteilen, in: *58. Tribologie-Fachtagung (GfT)*: 25.-27.09.2017, Göttingen, P9, 2017. (in German)
- [37] Paulovics, L., Németh, M., Knaup, J.: Alternative Verschleißmessverfahren für Steuerketten, in: Knaup, J. (ed.): *5. Győrer Tribologie- und Effizienztagung*, Győr, Universitas-Győr Nonprofit Kft., pp. 199-216, 2018. (in German)
- [38] Tabakov, Z. M., Paulovics, L.: Development of wear analysis of timing chain elements on a high frequency reciprocating rig, In: Dernóczy-Polyák, A. (ed.): *Kutatási jelentés 2. - Research Report*, Győr, Universitas-Győr Nonprofit Kft., pp. 248-252, 2020.
- [39] Paulovics, L., Kuti, R., Rohde-Brandenburger, J., Tóth-Nagy, C.: Development of comparative investigation method for timing chain wear analysis using oscillating tribometer. *Acta Technica Jaurinensis* 14 (4), pp. 406-423, 2021.
- [40] Scherge, M., Pöhlmann, K., Gervé, A.: Wear measurement using radionuclide-technique (RNT), *Wear*, vol. 254 (9), pp. 801-817, 2003.
- [41] Leo, W. R.: *Techniques for Nuclear and Particle Physics Experiments*, 2. ed., Springer-Verlag Berlin Heidelberg New York, 1994
- [42] Fink, T.: Development of High performing timing drives for internal combustion engines, Präsentation, *VDI-Fachkonferenz Umschlingungsgetriebe 2011 in Nuertingen*, December 14th and 15th, 2011.
- [43] Tandler, R., Bohn, N., Gabbert, U., Woschke, E.: Experimental investigations of the internal friction in automotive bush chain drive systems, *Tribology International*, vol. 140, no. July, p. 105871, 2019.
- [44] Lubricants — Determination of tribological quantities for oils and greases — Tribological test in the translatory oscillation apparatus, ISO 19291:2016
- [45] Standard Test Method for Linearly Reciprocating Ball-on-Flat Sliding Wear, ASTM G133 - 05(2016)
- [46] Reichelt, M., Cappella, B., Comparative Analysis of Error Sources in the Determination of Wear Volumes of Oscillating Ball-on-Plane Tests, in: *Frontiers in Mechanical Engineering*, vol. 6, p 25, 2020.
- [47] Tóth, Á. D., Szabó, I. Á., Kuti, R.: Tribological Properties of Nano-Sized ZrO<sub>2</sub> Ceramic Particles in Automotive Lubricants, *FME Transactions*, vol. 49, no. 1, pp. 36–43, 2021.
- [48] Tóth, Á. D., Szabó, I. Á., Leskó, M. Zs., Rohde-Brandenburger, J., Kuti, R.: Tribological Properties of the Nanoscale Spherical Y<sub>2</sub>O<sub>3</sub> Particles as Lubricant Additives in Automotive Application, *Lubricants* 10: 2, p. 28, 2022.
- [49] Trivedi, H. K., Bhatt D. V.: Effect of lubricants on the friction of cylinder liner and piston ring materials in a reciprocating bench test, *FME Transactions* 47, pp. 23-28, 2019.
- [50] Dudás, A., Laki, G., Nagy, A. L., Zsoldos, I., Hannula, B., Bartel, D.: Wear behaviour of ceramic particle reinforced atmospheric plasma spray coatings on the cylinder running surface of internal combustion engines, *Wear*, Volumes 502-503, 204373, 2022.
- [51] Papp, Cs., Kuti, R.: Identification of Engine Damages of Vintage Vehicles with Tribological Examination, *FME Transactions* 49, pp. 608–614, 2021.
- [52] Agocs, A., Besser, C., Brenner, J., Budnik, S., Frauscher, M., Dörr, N.: Engine Oils in the Field: A Comprehensive Tribological Assessment of Engine Oil Degradation in a Passenger Car. *Tribology Letters*. 70(1), 2022.
- [53] Tóth, Á. D., Paulovics, L., B. Hanula, B., Kopp, A., Knaup, J.: Methodenentwicklung zur Einstufung von Motorölen anhand tribologischer Eigenschaften, in: *58. Tribologie-Fachtagung (GfT)*: 25.-27.09.2017, Göttingen, P8, 2017.
- [54] Ratoi, M., Castle, R. C., Bovington, C. H., Spikes, H. A.: The influence of soot and dispersant on ZDDP film thickness and friction. *Lubrication Science*, 17(1), pp. 25–43, 2004.
- [55] Antusch, S., Dienwiebel, M., Nold, E., Albers, P., Spicher, U., Scherge, M.: On the tribochemical action of engine soot, *Wear*, Volume 269, Issues 1–2, pp. 1-12, 2010.

- [56] Hu, E., Hu, X., Liu, T., Fang, L., Dearn, K. D., Xu, H.: The role of soot particles in the tribological behavior of engine lubricating oils, *Wear*, Volume 304, Issues 1–2, pp. 152-161, 2013.
- [57] Uy, D., Ford, M. A., Jayne, D. T., O'Neill, A. E., Haack, L. P., Kangas, J., Jagger, M. J., Sammut, A., Gangopadhyay, A. K.: Characterization of gasoline soot and comparison to diesel soot: Morphology, chemistry, and wear, *Tribology International*, Volume 80, pp. 198-209, 2014.
- [58] Andersson, S.: Wear Simulation, in: *Advanced Knowledge Application in Practice*. London, United Kingdom: IntechOpen, 2010 [Online]. Available online: <https://www.intechopen.com/chapters/12340> (accessed on 10 March 2022)
- [59] Tong, D., Diao, Z., Sun, N., Du, X., Zhang, Y., Liu, Z.: A review of dynamic-tribological simulation methods for sliding bearings in internal combustion engines, *J. Phys. Conf. Ser.*, vol. 2101, no. 1, 2021.
- [60] Mudras, S. M. S.: Computer Simulation/ Prediction of Wear in Mechanical Components, *Advances in Tribology*, vol. 2020, Article ID 8867351, 15 pages, 2020.
- [61] Schmidt, A. A., Plánka, J., Schmidt, T., Grabherr, O., Bartel, D.: Validation of a dry sliding wear simulation method for wastegate bearings in automotive turbochargers, *Tribology International*, vol. 155, p. 106711, 2021.
- [62] Ottosson, H. J., Mattson, C. A., Johnson, O. K., Iron, I.: Use of simulation and wear prediction to explore design improvements to the cup seal in the India Mark II/III hand pump system, *Dev. Eng.*, vol. 7, p. 100092, 2022.
- [63] Yan, Y., Jiang, C., Li, W.: Simulation on coupling effects between surface wear and fatigue in spur gear, *Eng. Fail. Anal.*, vol. 134, p. 106055, 2022.
- [64] Zhang J., Lyu, F., Bing, X., Huang, W., Wu, W., Guo, Z., Xu, H., Huang, X.: Simulation and experimental investigation on low wear rate surface contour of piston/cylinder pair in an axial piston pump, *Tribology International*, vol. 162, p. 107127, 2021.
- [65] Tandler, R., Bohn, N., Gabbert, U., Woschke, E.: Analytical wear model and its application for the wear simulation in automotive bush chain drive systems, *Wear*, vol. 446–447, p. 203193, 2020.
- [66] Richard, J. F.: Contact and Rubbing of Flat Surfaces, *Journal of Applied Physics*, 24(8), pp. 981–988, 1953.
- [67] Fleischer, G.: Energetische methode der bestimmung des verschleißes, *Schmierungstechnik* 4.9, pp. 269-274, 1973. (in German)
- [68] Tandler, R., Bohn, N., Gabbert, U., Woschke, E.: Experimental investigations of the internal friction in automotive bush chain drive systems, *Tribology International*, vol. 140, no. July, p. 105871, 2019.

---

## МЕТОДЕ ИСПИТИВАЊА ХАБАЊА РАЗВОДНОГ ЛАНЦА – ПРЕГЛЕД

**Ј. Паулович, Ј.Р. Бранденбургер, Ч. Тот-Нађи**

Неколико метода се користи за испитивање хабања разводног ланца, од испитивања на динамометру мотора преко триболошког модела до симулација. Истраживања у протеклој деценији су показала да тестови компоненти или трибометара могу заменити скупе тестове динамометара мотора у многим случајевима. Методе симулације могу додатно смањити трошкове и време развоја. Симулациони модели захтевају експериментално дефинисане улазне параметре; стога се методе засноване на експериментима не могу у потпуности избећи. Међутим, свеобухватно поређење или валидација различитих експерименталних и симулационих техника је тешко, пошто је литература о овој теми релативно оскудна. Ова студија има за циљ да пружи систематско поређење резултата неколико метода истраживања хабања ланца разводног механизма, подржаних подацима измереним на Универзитету Сечењи Иштван, као што су тестови динамометра са упаљеним мотором, тестови хладних динамометара, тестови компоненти и тестови трибометра, представљајући њихове предности и ограничења, где је то могуће кроз примере и резултате. Студија такође пружа увид у компатибилност различитих метода мерења.